



Naturalis Repository

New taxonomic synopses and revision of the scombroid fishes (Scombroidei, Perciformes), including billfishes, from the Cenozoic of territories of the former USSR

Kenneth A. Monsch and Alexandre F. Bannikov

Downloaded from:

<https://doi.org/10.1017/S1755691011010085>

Article 25fa Dutch Copyright Act (DCA) - End User Rights

This publication is distributed under the terms of Article 25fa of the Dutch Copyright Act (Auteurswet) with consent from the author. Dutch law entitles the maker of a short scientific work funded either wholly or partially by Dutch public funds to make that work publicly available following a reasonable period after the work was first published, provided that reference is made to the source of the first publication of the work.

This publication is distributed under the Naturalis Biodiversity Center 'Taverne implementation' programme. In this programme, research output of Naturalis researchers and collection managers that complies with the legal requirements of Article 25fa of the Dutch Copyright Act is distributed online and free of barriers in the Naturalis institutional repository. Research output is distributed six months after its first online publication in the original published version and with proper attribution to the source of the original publication.

You are permitted to download and use the publication for personal purposes. All rights remain with the author(s) and copyrights owner(s) of this work. Any use of the publication other than authorized under this license or copyright law is prohibited.

If you believe that digital publication of certain material infringes any of your rights or (privacy) interests, please let the department of Collection Information know, stating your reasons. In case of a legitimate complaint, Collection Information will make the material inaccessible. Please contact us through email: collectie.informatie@naturalis.nl. We will contact you as soon as possible.

New taxonomic synopses and revision of the scombroid fishes (Scombroidei, Perciformes), including billfishes, from the Cenozoic of territories of the former USSR

Kenneth A. Monsch¹ and Alexandre F. Bannikov²

¹ Department of Geology, Naturalis Biodiversity Center, P.O. Box 9517, 2300 RA Leiden, The Netherlands
E-mail: kenneth.monsch@naturalis.nl

² Borisyak Paleontological Institute of the Russian Academy of Sciences, Profsoyuznaya 123, Moscow 117997, Russia
E-mail: aban@paleo.ru

ABSTRACT: We present an overview of all known fossil scombroid fishes (Scombroidei, Perciformes) of the former USSR, many taxa of which are described in a language other than Russian for the first time. Also new is the application of a cladistic framework for these taxa. For each taxon, short taxonomic synopses with the most relevant characteristics (synapomorphies, meristic counts) are presented in a form useful for future cladistic analysis. As an exception, we present an extensive systematic description of the billfish †*Hemingwaya sarissa* Sytchevskaya & Prokofiev, because we disagree with earlier interpretations. The ‘gempylid’ †*Hemithyrsites maicopicus* Daniltschenko retains its generic name, which is considered the valid name of what is also known as *Promethichthys* Gill. A new tribe, †*Eocoelopomini*, is erected to contain the genera †*Eocoelopoma* Woodward, †*Palaeothunnus* Bannikov, and †*Microrhynchus* Monsch. It is questioned whether species previously described as belonging to *Thunnus* South should be classified in that genus. A new species of tribe Scomberomorini, †*Neocybium parvidentatum*, is described from the Bartonian of W Kazakhstan. A specimen of †*Auxides* (questionably Maastrichtian, Iran), also reported here, possibly extends the radiation of †*Auxides*, and scombroids as a whole, further back in time. The fossil record of the Blochiidae is probably extended downwards to the Thanetian.



KEY WORDS: fossil fishes, Palaeogene, Neogene, taxonomic revisions and synopses, Xiphoidea

The outcrops of the former USSR have long been known as a rich source of fossil fishes (e.g. Bogachev 1933; Smirnov 1936; Danil’chenko 1960; Bannikov 1993d), including taxa of mackerel-like fishes (Teleostei, Perciformes, Scombroidei). The most comprehensive published records of fossil scombroids from these territories are Bannikov’s (1985) monograph of the fossil Scombridae from the Soviet Union and Bannikov’s (2010) overview of fossil acanthopterygians (not acanthomorphs: Paracanthopterygii are excluded) from Russia and adjacent countries. Even though many publications include these taxa, they are poorly known. The majority of relevant papers from the 1950s to 1990s were in poorly-available journals, and written in Russian. Neither are some rare English translations of those works (e.g. Danil’chenko 1967) well distributed. Moreover, the past few decades have seen many advances in scombroid systematics (Collette *et al.* 2001; Orrell *et al.* 2006; Little *et al.* 2010), and most of this new knowledge has not yet been applied to the Russian scombroids. Finally, the information content of these older papers is not sufficient for creating modern data matrices for cladistic analyses. The present paper is part of a larger programme by one of us (KAM), who is conducting an analysis of global scombroid phylogeny; a preliminary version of which is in his Thesis (Monsch 2000b).

The use for data of fossil taxa for biodiversity studies and research into phylogenies of Recent taxa has been well supported (e.g. Donoghue *et al.* 1989; Upchurch & Hunn 2001; Lieberman 2003). Data on fossil fishes from former Soviet territories have been used in the context of palaeoecological and palaeobiogeographical studies of a somewhat local character (e.g. Bannikov 1993d, 2010; Popov *et al.* 2002), but are certainly applicable on larger scales.

The aims of the present paper are two-fold. First, a complete overview is presented of all fossil scombroids of the former USSR. Secondly, by publishing the taxon accounts in English in a widely-distributed journal, this information will be available to a wide audience.

This paper is not just a translation of old literature. We include taxonomic revisions and redescrptions where needed, and incorporate data from newly-found specimens. Rather than repeating the extensive original descriptions, only short synopses, outlining (syn)apomorphies, autapomorphies, plesiomorphies that are essential for recognising the taxa, and the most important meristic counts and measurements, are presented. However, in cases where previously published descriptions are readily available, references are provided rather than a repetition of the original. Because there is no new phylogenetic analysis in this paper, knowledge about apomorphies

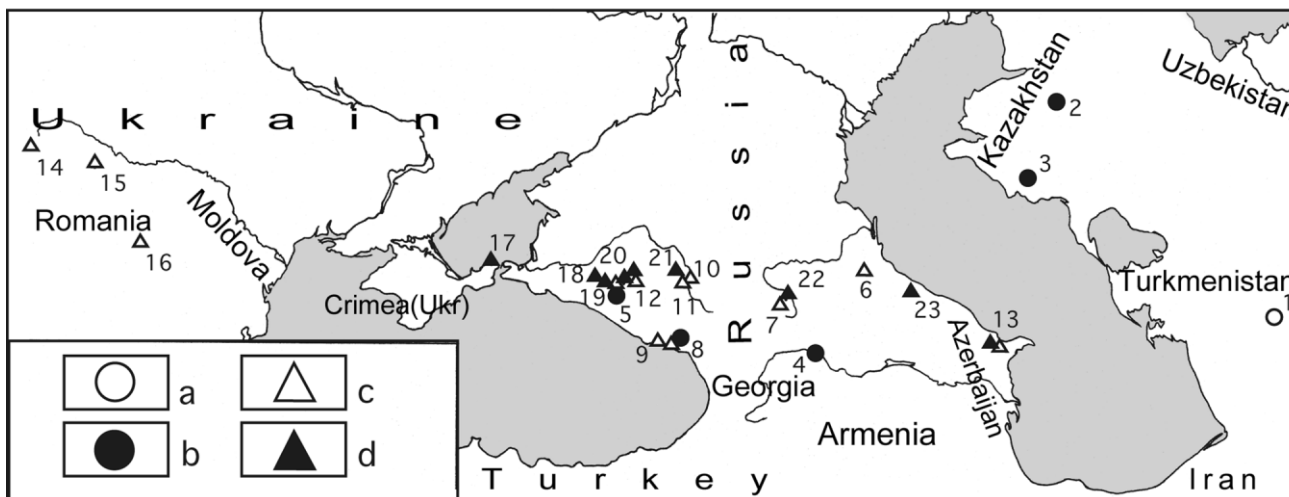

Figure 1 Principal localities of fossil scombroids in the former USSR and Romania: 1–aUilya-Kushlyuk; 2=western Ustyurt; 3=Mangyshlak; 4=Tbilisi; 5=river Pshekha; 6=river Sulak; 7=river Skumey-Don; 8=river Gumista; 9=Akhali-Afoni; 10=river Kuban; 11=river Malyi Zelenchuk; 12=river Belaya; 13=river Sumgait; 14=Verkhovina Bystraya; 15=Ukrainian Cis-Carpathians; 16=Piatra-Neamt; 17=cape Tarkhan; 18=Voskovaya Mount; 19=Shirvanskaya; 20=river Kurdzhips; 21=river Urup; 22=river Chyornaya; 23=river Ullu-Chai. Conventional signs: a=upper Palaeocene, b=Eocene, c=Oligocene, d=lower-middle Miocene.

and other characters is necessarily drawn from previous publications.

1. Geological setting

The principal localities of fossil scombroids from the former USSR, including those mentioned in this section, are shown in Figure 1.

The most ancient scombroids from the territories of the former USSR are known from the Thanetian (terminal Palaeocene) deposits of the Danata Svita in Turkmenistan (W Kopet Dagh, locality at Uilya Kushlyuk). The fish-bearing layer of the Danata Svita lies between the lower part (Thanetian) and middle part (Ypresian) of the Danata Svita. This layer lacks microfossils, hence its age is somewhat questionable. Usually (e.g. Danil'chenko 1968; Bannikov 1985) it is regarded as late Palaeocene, although sometimes it is mentioned as early Eocene (e.g. Patterson 1993; Bannikov & Tyler 1995). Muzylev (1994) supposes that the fish-bearing layer of the Danata Svita is synchronous with the upper Thanetian sapropel of more western regions, corresponding to global late Palaeocene anoxic events. Scombroids are well represented in the upper Thanetian fish fauna of Turkmenistan; seven taxa are described from there, in addition to the unidentified possibly †blochiid (Bannikov 1993d, 2010; Bannikov & Parin 1997): the †euzaphlegid †*Palimphytes palaeocenicus* Danil'shenko, 1968 (when associated with the names of taxa, the Latinised version of P. G. Danil'chenko's name, in the manner he himself preferred and spelled in his papers, is used. In the literature references the more commonly cited western spelling is given), †*Argestichthys vysotzkyyi* Prokofiev, 2002 ("Gempylidae"), †*Auxides turkmenicus* (Danil'shenko, 1968), †*Eocoelopoma portentosum* Bannikov, 1985, †*Palaeothunnus parvidentatus* Bannikov, 1978, †*Scomberomorus avitus* Bannikov, 1985 (Scombridae) and †*Hemingwaya sarissa* Sytchevskaya & Prokofiev, 2002 (†Hemingwayidae).

Early Eocene marine fishes are unknown from the territories of the former USSR, whereas middle Eocene fishes are relatively well represented in two fish assemblages. The older of these is the assemblage of the Dabakhana Svita of Georgia (locality in Tbilisi). This sedimentary-tuffaceous formation approximately corresponds to the middle Lutetian of W

Europe (Stratigraficheskiy Slovar' SSSR 1982). Mesopelagic fishes predominate in the Dabakhana fish fauna, and four scombroids – †*Palimphytes pimatus* Danil'shenko, 1962 (†Euzaphlegidae), †*Anenichelum eocaenicum* (Danil'shenko, 1962) (Trichiuridae), †*Auxides devius* (Danil'shenko, 1962) (Scombridae) and †*Palaeorhynchus senectus* Danil'shenko, 1962 (†Palaeorhynchidae) – are also described (Danil'chenko 1962).

Marine fishes of Bartonian age are more widespread in the territories of the former USSR, from deposits of the Kuma Horizon of the North Caucasus (the main locality is on the bank of the river Pshekha) and the Shorym Svita of the Mangyshlak peninsula (W Kazakhstan). The former locality yields better preserved, mostly articulated fish skeletons, whereas most fish remains in Mangyshlak are represented by isolated bones and fragments. Scombroids of the Kuma Horizon are as follows: †*Palimphytes pshekhaensis* Bannikov, 1993b (†Euzaphlegidae); †*Anenichelum paucivertebrale* Bannikov & Parin, 1995 (Trichiuridae); †*Thunnus' abchasicus* Danil'shenko, 1951 (Scombridae); and †*Palaeorhynchus parini* Bannikov, 1992 (Palaeorhynchidae). The scombrids †*Scomberomorus saevus* Bannikov, 1982, †*Neocybium parvidentatum* sp. nov., †*Gymnosarda prisca* Monsch, 2000a and *Sarda* sp. (Bannikov 1985, 2010; Monsch 2000a) are recorded from the Shorym Svita of Mangyshlak.

Priabonian marine fishes are poorly known from the territories of the former USSR. Scales and fragments of the large elopid †*Lyrolepis caucasica* Romanovsky, 1886 and very rare fragments identified as †*Thunnus' abchasicus* are reported from deposits of the Belaya Glina Horizon (Beloglinian regional stage: Popov *et al.* 2002) in the North Caucasus.

According to Popov *et al.* (2002, p. S191), "In the Rupelian, the depositional environments ... in the Paratethys markedly changed ... This resulted in the formation of ... water stratification, impairment of gas exchange regime, hydrogen-sulphide contamination, and accumulation of dark-coloured clay sediments ... (menilithic beds in the Carpathian area and the Maykopian in the Caucasus–Kopet Dagh area of the Paratethys)". Lower Maykopian deposits of the North Caucasus (Pshekha Horizon or Pshekhan regional stage) can be divided in two parts: lower (*Planorbella* Beds) and upper (*Aeoliscus* Beds) (e.g. Danil'chenko 1960); fish fauna of the

Pshekha Horizon is known from many localities in the North Caucasus, Abkhazia and Azerbaijan. Based on the composition of the Pshekha Horizon fish fauna, Sytchevskaya (in Popov *et al.* 2002) recognised also sub-*Planorbella* Beds, and divided the *Planorbella* Beds in two parts. Recent field observations in the outcrops could not confirm the possibility of such a division. The diverse fish assemblage of the Pshekha Horizon includes, among others, ten taxa of scombroids: †*Palimphytes chadumicus* Danil'tshenko, 1960 (†Euzaphlegidae); †*Anachelum angustum* (Danil'tshenko, 1980); †*A. glarisanum* de Blainville, 1818 (Trichiuridae); †*Abadzekhia tarletskovi* Bannikov, 2005 (stem trichiurid); †*Auxides cernegurae* (Ciobanu, 1970); †*Sarda rara* Bannikov, 1979a; *Thunnus* sp.; *Thunnini inc. sed. sp.* (Scombridae); †*Palaeorhynchus zitteli* (Kramberger, 1879); and †*Homorhynchus colei* (Agassiz, 1844) (Bannikov & Parin 1997; Bannikov 2010). Most of the specimens were collected in *Planorbella* Beds. In the Menilithic–Krosno Series of the Polish Carpathians, six ichthyofaunistic zones (IPM) were distinguished by Jerzmańska & Kotlarczyk (1981). The lowermost of these, IPM-1, is probably correlated with the Pshekha Horizon of the Caucasus. Specimens of †*Anachelum glarisanum*, †*Auxides cernegurae* and †*Palaeorhynchus zitteli*, which are now in the collections of PIN were, perhaps, collected in deposits of this zone of the Ukrainian Carpathians.

At the end of the Rupelian, the isolation of Paratethys resulted in a change of the hydrological regime to brackish water, and marine environments were restored in Eastern Paratethys at the terminal Rupelian–early Chattian (Kalmykian regional stage) (Popov *et al.* 2002). Chattian fishes of the Caucasus are much less numerous and diverse, and these are poorly studied. In the lower Kalmykian deposits of the Belaya River (NW Caucasus) †*Abadzekhia marinae* Bannikov, 1985 (stem trichiurid) and †*Sarda remota* Danil'tshenko, 1980 (Scombridae) were recorded. One more scombrid, †*Scomber cubanicus* Danil'tshenko, 1960, and the palaeorhynchid †*Pseudotetrapturus luteus* Danil'tshenko, 1960 are described from the upper Kalmykian or Karadzhhalga (Karadialganian: Popov *et al.* 2002) deposits of the Caucasus. Scombrids †*Scomber voiteştii* Paucă, 1929b and †*Thunnus secretus* Bannikov, 1979b were collected from the Chattian of the Ukrainian Carpathians.

A relatively diverse marine fish assemblage is known from the upper Maykopian (lower Burdigalian, zones NN2–NN3) deposits of the Caucasus and Crimea. Among others, four taxa of scombroids were described from there: †*Hemithyrsites maicopicus* Danil'tshenko, 1960 (basal trichiurid); *Anachelum lednevi* (Menner, 1949) (Trichiuridae); †*Scomber gnarus* Bannikov, 1979a; and †*Sarda memorabilis* Danil'tshenko, 1980 (Scombridae). Most specimens of early Miocene fishes were collected at four localities: the Kerch peninsula (the Crimea), Pshekha River (NW Caucasus), river Chyornaya, N Osetiya (N Caucasus) and Islamdagh mount (Azerbaijan).

The Eastern Paratethys freshened at the end of the Burdigalian (Kozahurian: Popov *et al.* 2002), and marine environments were restored there in the Tarkhanian. The fish fauna is known from the *Spirialis* clays (deepwater facies of the Tarkhanian and Chokrakian, corresponding to the Langhian) of the Caucasus and Crimea. Of the scombroids, only the trichiurid †*Lepidopus lateralis* Danil'tshenko, 1980 is recorded from these deposits of the Apsheron Peninsula (Azerbaijan).

The presence of scombroids of the former USSR is not confirmed from deposits younger than Chokrakian, except for some fragments of *Scomber* Linnaeus, 1758 found in the lower Sarmatian, or Volhynian (Serravallian), of the N Caucasus (Carnevale *et al.* 2006).

2. Material and methods

2.1. Material

The vast bulk of the material is housed in PIN. Only a few type specimens of certain species are kept elsewhere. Not all specimens that have been diagnosed as scombroids are included in the material studied for this paper. There are many fossil fishes from the former USSR that have historically been interpreted as scombroids, but which are problematic. These are mentioned below.

Bannikov (1993c) transfers †*Isurichthys* Woodward, 1901 from the scombroids to the stromateoid family Ariommidae (Ariommatidae). †*Isurichthys* does not possess any diagnostic apomorphies of scombrids: additional dorsal and anal finlets (see e.g. Collette 1978), for example, are missing. The removal of this genus from the family Scombridae is therefore justified. Bannikov (1993c) noticed remarkable resemblances between the Recent *Ariomma* Jordan & Snyder, 1904 and a fossil specimen of †*Isurichthys*. These similarities are, among others, the structure of the dorsal and anal fins and their pterygiophores, as well as the number of vertebrae. The caudal skeleton of †*Isurichthys* seems to be more weakly consolidated than in *Ariomma* (Baciu & Bannikov 2004). Recently, direct evidence of the presence of a toothed pharyngeal sac in the oesophagus of *Isurichthys* was discovered, which confirms a stromateoid affinity of this genus (see Bannikov 2012 for more information).

Nesov and co-authors describe several fish taxa from the Palaeocene of Kazakhstan (Averianov *et al.* 1993) and the Eocene of Uzbekistan (Udovichenko & Nesov 1987), based on fragmentary material stored at CNIGR. We do not consider their scombrid taxa for the following reasons. The species †*Scomberomorus akkumensis* (Averianov *et al.* 1993) from the Palaeocene locality Dzhilga (Kazakhstan) is not valid. Although the authors studied fragments of the premaxilla and dentary that perhaps indeed belong to *Scomberomorus* Lacépède, 1802, Averianov *et al.* (1993) chose as the holotype of †*S. akkumensis* the hypural plate of either a sardine or thunnine. The new scombrid genus and species †*Xenoscombrinus tripletodon* from the same locality is based on jaw fragments (Averianov *et al.* 1993). The present authors regard 'horizontal' tooth replacement in this taxon as unique among teleosts. However, rostral-lateral movement of teeth is not evident from the figures (Averianov *et al.* 1993, pl. 7, figs 1–3). Therefore the main diagnostic feature of †*Xenoscombrinus* is dubious. Finally, Udovichenko & Nesov (1987) described the †blochiid †*Cylindracanthus ianuaris* from the middle Eocene of Uzbekistan, based on fragments of rostral spines. Recently, the genus †*Cylindracanthus* Leidy, 1856 was excluded from the Blochiidae, and it may even not be a fish (Fierstine & Monsch 2002; Monsch 2005).

Bogachev (1933) described the scombrid †*Scomber caucasicus* from the Sarmatian of Chechnya, based on a single incomplete skeleton. The location of this specimen is unknown and there are no Sarmatian scombrids in the collection of PIN, except for few fragments of †*Scomber* aff. *caucasicus* (Carnevale *et al.* 2006) from the Pshekha River.

Institutional abbreviations. AMRS: Abkhazian Museum of Regional Studies, Sukhumi, Abkhazia; BMNH: Natural History Museum, London; BSP: Bayerische Staatssammlung für Paläontologie und Historische Geologie, Munich; CNIGR: Chernyshev Central Scientific Research Museum of Geological Exploration, St Petersburg, Russia; GLAHM: University of Glasgow, Hunterian Museum, Glasgow; HLMD: Hessischen Landesmuseums, Darmstadt, Germany; MNHN: Muséum National d'Histoire Naturelle, Paris; MSNP: Muséum de

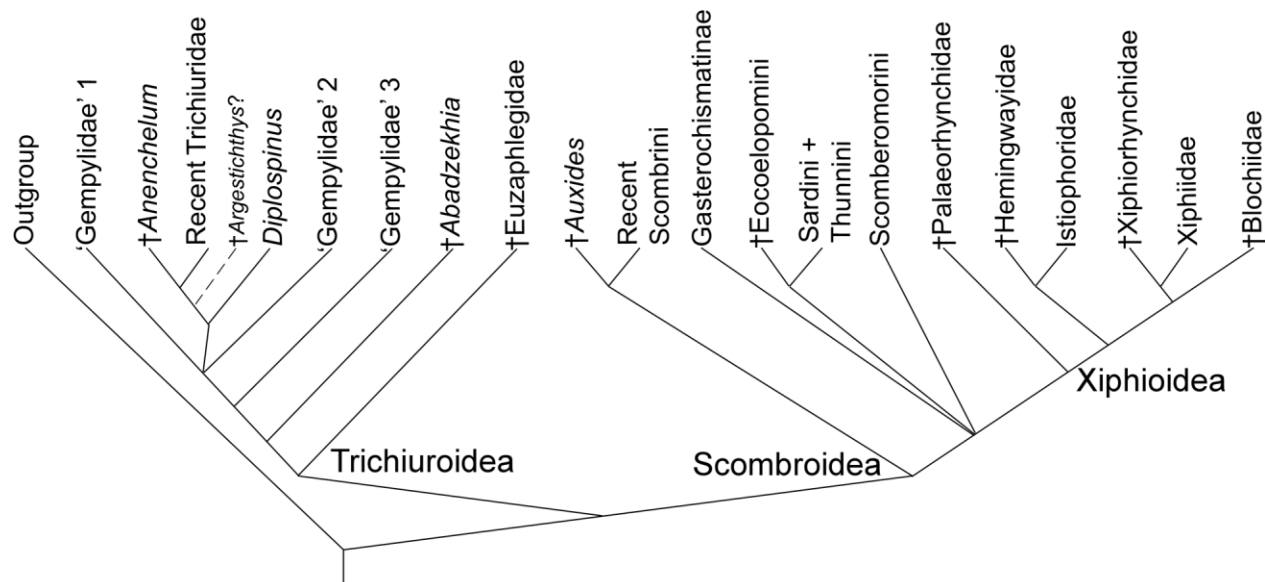

Figure 2 Cladogram depicting the systematic framework of our classification, based on Carpenter *et al.* (1995) (but with Sphyraenoidea in the outgroup), and Fierstine & Monsch (2002). 'Gempylidae' 1 contains *Thyrstitoides* Fowler, 1929; *Ruvettus* Cocco, 1829; *Epinnula* Poey, 1854; *Nesiarchus*, Johnson, 1862; *Thyrstitops* Gill, 1862; *Promethichthys* Gill, 1893; *Nealotus* Johnson, 1865 and *Gempylus* Cuvier, 1829. 'Gempylidae' 2 contains *Rexea* Waite, 1911; *Thyrstites* Lesson, 1831; and *Neoepinnula* Matsubara & Iwai, 1958. 'Gempylidae' 3 contains *Tongaichthys* Nakamura & Fujii, 1983 and *Lepidocybium* Gill, 1862.

Științe Naturale Piatra Neamț, Romania; PIN: Russian Academy of Sciences, Borisyak Paleontological Institute, Moscow; TM: Teylers Museum, Haarlem, The Netherlands; TMRS: Transcarpathian Museum of Regional Studies, Uzhgorod, Ukraine; USNM: National Museum of Natural History, Smithsonian Institution, Washington DC; ZPalWr: Palaeontological Collection of the Institute of Zoology, University of Wrocław, Poland.

2.2. Methods

In this paper, the systematic palaeontology is based on the most recently published complete cladistic study of scombroidea based on morphology (Carpenter *et al.* 1995) with a modified classification of Recent and fossil billfish, which in turn is based on Fierstine & Monsch (2002). Sphyraenids, regarded as the most primitive scombroidea by Johnson (1986), are excluded from consideration (see also Bannikov 2010). Carpenter *et al.* (1995) presented four cladograms that resulted from analyses of their data matrix. One of these (their fig. 5) was concurrent with the classification they proposed (their table 3). An implication of this classification was that the traditional division of Gempylidae and Trichiuridae into two different groups was to be abandoned: Trichiuridae are highly nested within a clade that otherwise include the traditional Gempylidae (Carpenter *et al.* 1995, fig. 5). The taxon comprising of 'Gempylidae' and Trichiuridae is named Superfamily Trichiuroidea in the present paper. The systematic palaeontology includes genera whose phylogenetic position can only be assessed tentatively. Figure 2 is a simplified and modified version of Carpenter *et al.*'s (1995, fig. 5) cladogram. The picture is modified by using the billfish relationships of Fierstine & Monsch (2002) and by including the fossil genera of that paper in their hypothesised places. In the systematic palaeontology section, there are explanations for why the fossils are provisionally placed where they are. Two things should be noted at this point. First, to determine the actual placing of the fossil taxa, a new cladistic analysis is necessary. The present paper does not include such an analysis, but this work is in progress. Fossils cannot be simply grafted into an existing phylogenetic framework without further consideration, since additional taxa may overthrow previously

established hypotheses (see e.g. Gauthier *et al.* 1988; Day 2003; Arratia 2010). Hence, the phylogenetic relationships of the extinct taxa are provisional and should still be tested. Secondly, the traditional classification of billfishes within scombroidea, as maintained in this present paper, is highly uncertain. Recent molecular studies point to a separation of suborder Xiphoidei from the Scombroidei (e.g. Orrell *et al.* 2006; Smith & Wheeler 2006; Li *et al.* 2009; Little *et al.* 2010). Gosline (1968) already suggested this separation, and it is followed by Bannikov (2010), albeit in a non-cladistic framework. To a certain degree, these authors considered which morphological apomorphies would support the relationships in their molecular trees (except Li *et al.* 2009). However, there is no recent morphological study that tests either these relationships, or the role of the characters that would support them. Because systematic palaeontology can only be based on morphology, the most recently published morphological trees form the framework of this present paper, and in those hypotheses, billfishes are part of the scombroidea.

To define taxa in a cladistic framework, one needs to know which character states are apomorphic or plesiomorphic. For Recent taxa, we refer to the explanation of character states used in Carpenter *et al.*'s (1995, table 1) data matrix. For Xiphoidea, the apomorphies found in the xiphioid hypothesis of Fierstine & Monsch (2002) are applied. For the clades shown in Figure 2 that are formed by grafting in the fossils, hypothetical apomorphies are provided in the present paper. Other sources of phylogenetically relevant traits used are Nakamura (1983, 1985) for billfishes; Russo (1983) and Nakamura & Parin (1993) for 'gempylids'; Nakamura & Parin (1993) and Gago (1997, 1998) for trichiurids; and Collette (1978) and Collette & Nauen (1983) for scombroidea in general. The systematic palaeontology section gives explanations of the apomorphic and plesiomorphic nature of relevant characters.

Because of the cladistic framework, taxon diagnoses in this present paper consist only of synapomorphies, through which diagnosis equals taxonomic definition (Monsch 2003). Other distinguishing characters that are plesiomorphic or whose nature (apomorphic or plesiomorphic) is not known are mentioned separately (Other distinguishing characters).

Traditionally, osteological terminology of scombroids is mostly based on de Sylva (1955). There are some changes as a result of recent work. 'Predorsal bones', for example, are named supraneurals (Mabee 1988) in this paper. The space between the neurocranium and the first neural spine is named the preneural space, and the space between the first and second neural spines is considered the first interneural space (see Birdsong *et al.* 1988; Bannikov & Tyler 1995), rather than the first and second interneural space, respectively.

The order in which the species are mentioned within their genus in the systematic palaeontology section is according to stratigraphic age, with the oldest species being described first. In literature dealing with palaeontology and geology of areas formerly of the USSR, the Soviet stratigraphic classification and nomenclature, which contains subdivisions such as Horizon and Svita, are still the norm. For a comparison between Soviet and British stratigraphic conventions see Holland (1983).

We do not provide complete lists of the studied specimens, because in many cases, the hypodigm is very large (up to about 150 specimens for some taxa). Under the heading 'Hypodigm', the total number of specimens and the institutions in which they are deposited are listed. All specimens in the collection of PIN are to be considered as 'referred specimens'. Should anyone require more precise details of the specimens, please contact one of the present authors, AFB.

Some of the specimens that are part of the hypodigm lack certain specific apomorphies. Despite that, the specimens in question can still be assigned to certain species, based on the age and geographic location of the sites from which they were collected. There are clearly strict demarcations in the geographical and stratigraphic distribution of these taxa (see Bannikov 1985, 2010).

In the synonymies and the descriptions below, Danil'chenko (1960) is frequently referred to. An exact English translation of that paper also exists (Danil'chenko 1967).

3. Systematic palaeontology

Suborder Scombroidei Bleeker, 1859

Superfamily Trichiuroidea Rafinesque-Schmaltz, 1810

Family †Euzaphlegidae Daniltshenko, 1960

Remarks. †Euzaphlegidae is a fossil family of primitive scombroid fish. Its most recent diagnoses are given by Bannikov (2008, 2010). Based on a preliminary cladistic analysis that did not contain all members of this family, Monsch (2000b) suspects that †euzaphlegids are a polyphyletic taxon (see also Patterson 1993). For now, until robust cladistic data are available, we tentatively follow previous taxonomies (e.g. Danil'chenko 1960; Bannikov 1993b) that treat the family as monophyletic. This paper contains hence no definition of †Euzaphlegidae, nor a discussion of their monophyly, which requires investigation. The †Euzaphlegidae are provisionally placed as the most distal branch on the trichiuroid stem. †Euzaphlegids are considered to be closely related to 'gempylids' (David 1943). Monsch (2000b) mentions that in †*Palimphytes* Agassiz, 1844 (the only †euzaphlegid known from Russian and adjacent territories) the dorsal pterygiophores overlap strongly to form a chain-like structure, which is a synapomorphy of trichiuroids (Johnson 1986; Gago 1997). This feature is not easily found in fossils and hard to capture in a photograph. Figures 3–16 are of taxa with this apomorphy; Figures 17–46 are of those without. A chain-like structure of somewhat overlapping pterygiophores is best seen in Figures 7 and 12 and, to a lesser degree in Figure 16. The plesiomorphic

state is best seen in Figures 38 and 41, where the pterygiophores are only loosely connected and not overlapping.

Subfamily †Dipterichthyinae Arambourg, 1967

Genus †*Palimphytes* Agassiz, 1844

Type species. †*Palimphytes longus* Agassiz, 1844 (=†*Clupea elongata* de Blainville, 1818, p. 315).

Diagnosis. Lower jaw slightly protrudes upper jaw. Operculum with caudal notch. Vertebrae 32–39 in number. Pectoral fin long, often reaching up to second dorsal fin. Dorsal fins not closely adjoined, separated by rayless pterygiophores. Dorsal pterygiophores overlap strongly, forming chain-like structure. Caudal skeleton (Fig. 3) contains two hypural plates: hypurals 1–2 and 3–4 (–5?), respectively, fused together (sometimes, remnants of fusions between hypurals 1–2 and 3–4 still visible). Two or, rarely, three epurals present. Second preural vertebra with remarkably deformed neural spine, which is not elongated and widened in the antero-caudal plane.

Remarks. Pharissat (1991, fig. 46) figures a reconstruction of †*P. elongatus* (de Blainville, 1818), in which there are two strongly adjoined dorsal fins. This configuration is not supported by specimens seen during the present study or before (Bannikov 1993b).

†*Palimphytes palaeocenicus* Daniltshenko, 1968
(Fig. 3)

1968 †*Palimphytes palaeocenicus* Danil'chenko, p. 143, text-fig. 2, pl. 34, figs. 1, 2.

1980 †*Palimphytes palaeocenicus* Dan. Danil'chenko, p. 145.

1993 †*Palimphytes palaeocenicus* Dan. Patterson, p. 649 (name only).

1997 †*Palimphytes palaeocenicus* Dan. Bannikov & Parin, p. 134 (name only).

2000b †*Palimphytes palaeocenicus* [sic] Dan. Monsch, p. 101, fig. 7.14.

2010 †*Palimphytes palaeocenicus* Dan. Bannikov, p. 126, pl. XIX, fig. 5.

Holotype. PIN 2179/83 (Fig. 3a, b).

Type locality. Uilya-Kushlyuk, Turkmenistan; upper Palaeocene (Thanetian, Danata Svita).

Diagnosis. Vertebrae 32 (13+19) in number. Three epurals. First dorsal fin consists of seven spines. First pterygoid of first dorsal fin inserted in second interneural space. Three rayless pterygiophores between dorsal fins. Second dorsal fin with one spine and 15–16 rays. Anal fin with of two spines and 15 rays. Remnants of fusions between hypurals visible (Fig. 3b).

Hypodigm. Eleven specimens from the type locality (PIN).

Description. Maximum body depth ca. 26% of standard length. Lower jaw length ca. 61% of head length. More details in Danil'chenko 1980.

†*Palimphytes pinnatus* Daniltshenko, 1962
(Fig. 4)

1962 †*Palimphytes pinnatus* Danil'chenko, p. 119, fig. 8.

1980 †*Palimphytes pinnatus* Dan. Danil'chenko, p. 145.

1993d †*Palimphytes pinnatus* Dan. Bannikov, fig. 2C (name only).

1997 †*Palimphytes pinnatus* Dan. Bannikov & Parin, p. 135 (name only).

2010 †*Palimphytes pinnatus* Dan. Bannikov, p. 126, text-fig. 70.

Holotype. PIN 1413/77.

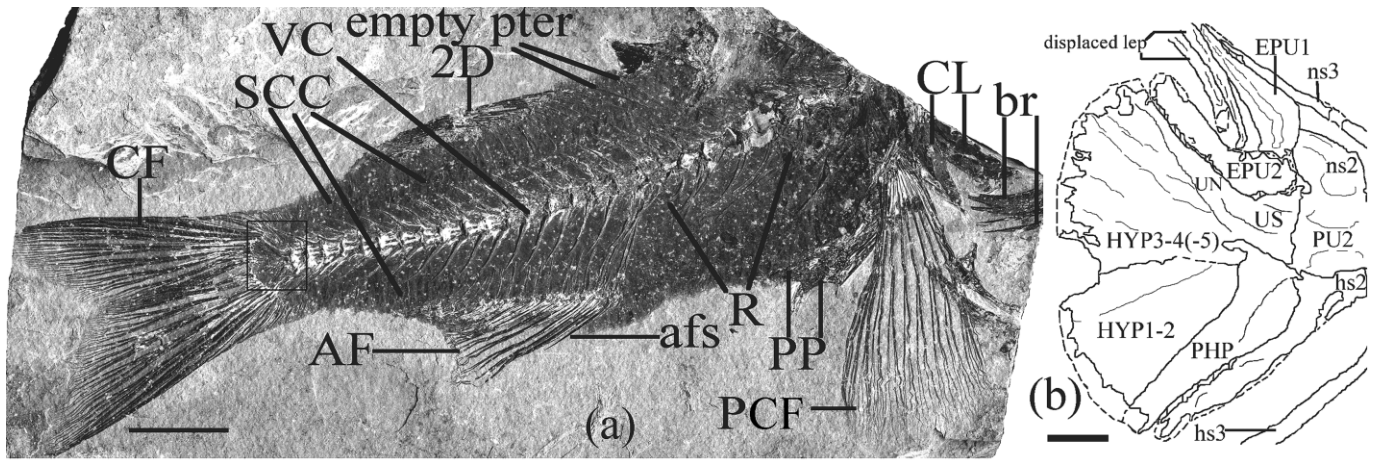

Figure 3 †*Palimphyes palaeocenicus*, holotype, PIN 2179/83, Uilya-Kushlyuk, Turkmenistan; Thanetian: (a) whole specimen, scale bar=10 mm; (b) line drawing of tail region, taken from rectangle in (a), scale bar=1 mm. Abbreviations: 2D=second dorsal fin; AF=anal fin; afs=anal-fin spine; br=branchiostegal rays; CF=caudal fin; CL=cleithrum; EPU=epural; hs=haemal spine; HYP=hypural; lep=lepidotrichium; ns=neural spine; PU=preural vertebra; PP=pelvic plate; R=ribs; SCC=scale covering; UN=uroneural; US=urostyle; VC=vertebral column.

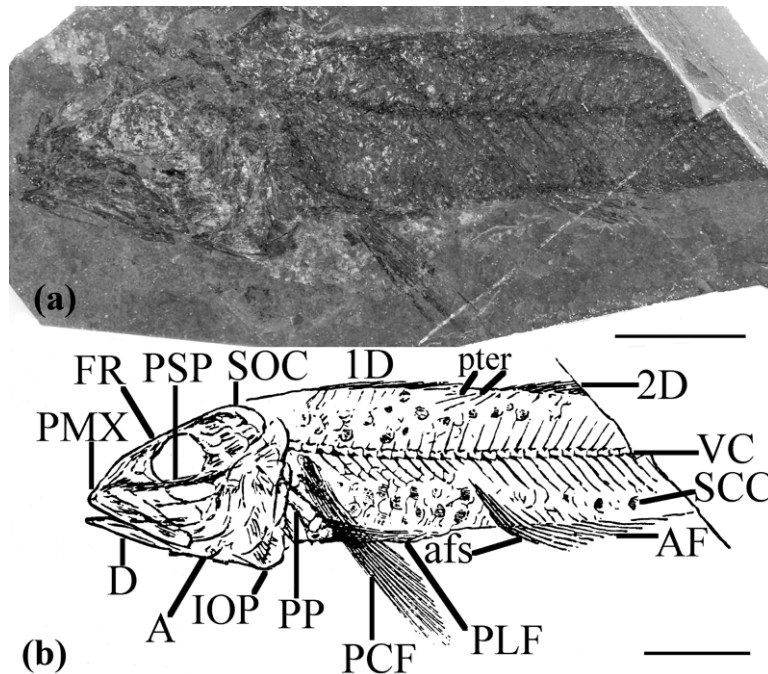

Figure 4 †*Palimphyes pinnatus*, holotype, PIN 1413/77, Tbilisi, Georgia; Lutetian: (a) photograph of holotype; (b) line drawing of Danil'chenko (1962, fig. 8) with added labels. Scale bar=10 mm. Abbreviations: 1D=first dorsal fin; 2D=second dorsal fin; A=angular; AF=anal fin; afs=anal-fin spine; D=dentary; FR=frontal; IOP=interopercular; PCF=pectoral fin; PLF=pelvic fin; PMX=premaxilla; PP=pelvic plate; PSP=parasphenoid; pter=pterygiophores; SCC=scale covering; SOC=supraoccipital crest; VC=vertebral column.

Type locality. Tbilisi, Georgia; middle Eocene (Lutetian, Dabakhana Svita).

Diagnosis. 35–36 (13–14+21–22) Vertebrae. First dorsal fin with 9–10 spines. Second dorsal fin with one spine and 14–15 rays, anal fin with two spines and 15–17 rays.

Hypodigm. Eight specimens from the type locality (PIN).

Description. Maximum body depth 18–22% of standard length. Lower jaw length 53–56% of head length. More details in Danil'chenko 1962, 1980.

Remarks. It cannot be assessed with certainty into which interneural space the first dorsal pterygiophore is inserted (possibly into the second). As in †*P. palaeocenicus*, the first spine of the fin is situated above the fifth (sometimes above the sixth) vertebra. Similarly, the number of rayless pterygiophores

between the dorsal fins is difficult to assess, as there may be two or three.

†*Palimphyes pshekhaensis* Bannikov, 1993b
(Figs 5–6)

1993d †*Palimphyes* sp. nov. Bannikov, fig. 3A (*nomen nudum*).

1993b †*Palimphyes pshekhaensis* Bannikov, p. 98, figs. 1, 2.

1997 †*Palimphyes pshekhaensis* Ban. Bannikov & Parin, p. 135 (name only).

2000b †*Palimphyes pshekhaensis* Ban. Monsch, p. 102, fig. 7.15.

2010 †*Palimphyes pshekhaensis* Ban. Bannikov, p. 127, pl. XX, fig. 2, text-fig. 71.

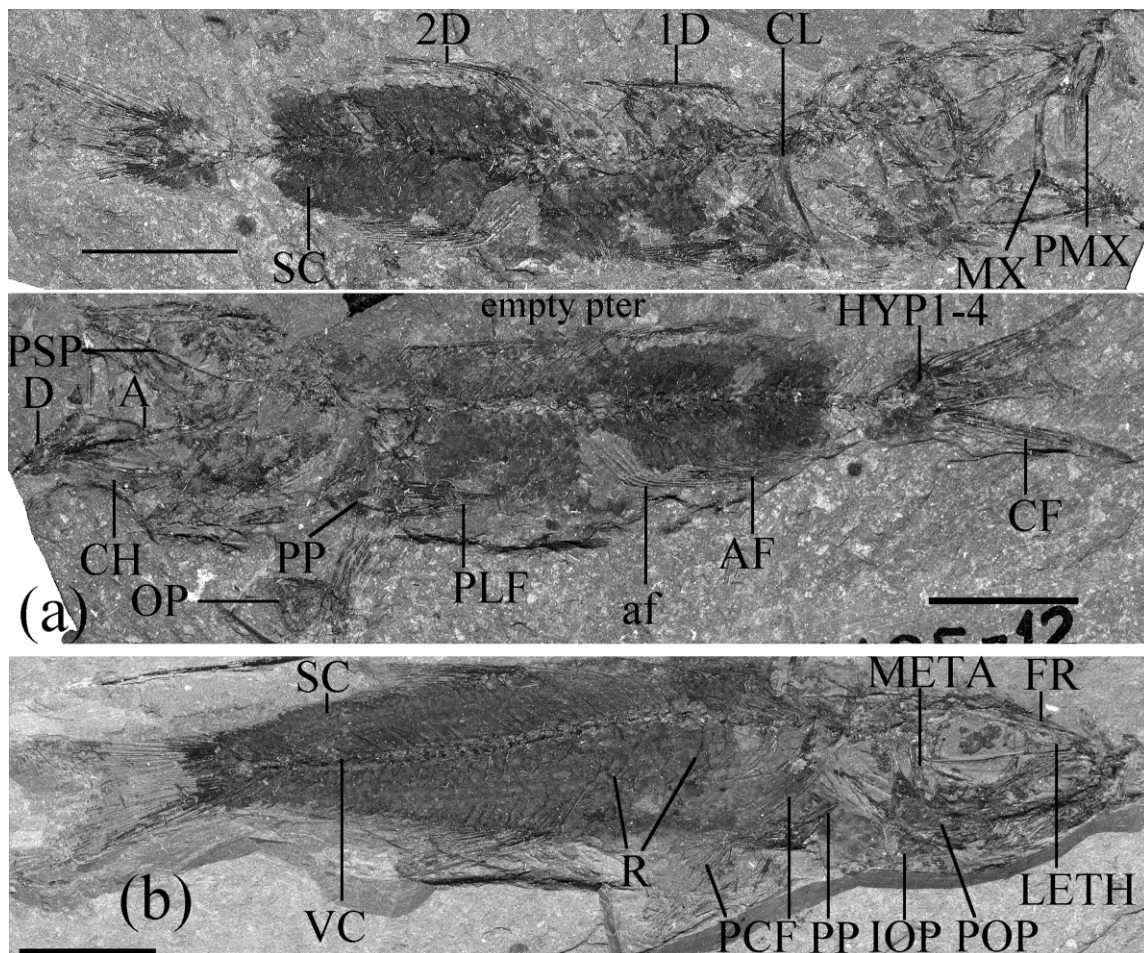

Figure 5 †*Palimphyes pshekhaensis*, left bank of river Pshekha, N Caucasus, Russia; Bartonian: (a) two counterparts of holotype, PIN 4425/12; (b) paratype, PIN 4425/7. Scale bars=10 mm. Abbreviations: 1D=first dorsal fin; 2D=second dorsal fin; A=angular; AF=anal fin; af=anal-fin spine; CF=caudal fin; CH=ceratohyal; CL=cleithrum; D=dentary; FR=frontal; HYP=hypural; IOP=interopercular; LETH=lateral ethmoid; META=metapterygoid; MX=maxilla; OP=opercular; PCF=pectoral fin; PLF=pelvic fin; PMX=premaxilla; POP=preopercular; PP=pelvic plate; PSP=parasphenoid; pter=pterygiophores; R=ribs; SC=scale covering; VC=vertebral column.

Holotype. PIN 4425/12 (Fig. 5a).

Type locality. Left bank of river Pshekha, 1 km upstream from Gorny Luch, Caucasus, Russia; upper middle Eocene (Bartonian, Kuma horizon).

Diagnosis. Hyomandibular relatively strongly inclined ventro-rostrad, compared to other species. Premaxilla has a small fang (Fig. 6). Operculum ornamented with numerous pits. 37 (16+21) vertebrae. First dorsal fin with 8–9 spines, its first pterygiophore inserted into third interneural space. Three rayless pterygiophore between first dorsal and second dorsal fin, the latter consisting of one spine and 19–20 rays (20 in Bannikov, 1993b). Anal fin with two spines and 20 rays.

Hypodigm. Thirty-eight specimens from the type locality (PIN).

Description. Maximum body depth 21–24% of SL. Lower jaw length 50–57% of head length. More details in Bannikov (1993b), who mentions that the pectoral fin has ≥ 12 rays. Current observations suggest a range between 13 and 20 rays (the holotype, paratype and PIN 4425/73).

Remarks. The only other species known to possess a premaxillary fang is †*Palimphyes* (=†*Dipterichthys*) *leptosomus* (Arambourg, 1967) (see Bannikov, 1993b). In Bannikov (1993d, fig. 3A) a specimen of †*P. pshekhaensis* (PIN 4425/7) was pictured, but do note that the captions for figures 2 and 3 were reversed.

†*Palimphyes chadumicus* Danil'tshenko, 1960 (Fig. 7)

1960 †*Palimphyes chadumicus* Danil'chenko, p. 137, text-fig. 27, pl. 13, figs. 3, 4.

1962 †*Palimphyes chadumicus* Dan. Dzhaferova, p. 49, fig. 4.

1964 †*Palimphyes chadumicus* Dan. Danil'chenko, pl. 7, fig. 5.

1980 †*Palimphyes chadumicus* Dan. Danil'chenko, p. 146, pl. 6, fig. 1.

1980 †*Palimphyes longirostratus* Danil'chenko, p. 147, text-fig. 48, pl. 6, fig. 2.

1997 †*Palimphyes chadumicus* Dan. Bannikov & Parin, p. 137 (name only).

?1997 †*Palimphyes longirostratus* Dan. Bannikov & Parin, p. 137 (name only).

2000b †*Palimphyes chadumicus* Dan. Monsch, p. 100, fig. 7.12.

2010 †*Palimphyes chadumicus* Dan. Bannikov, p. 127, pl. XX, fig. 4.

Holotype. PIN 290/3.

Type locality. River Skumey-Don, N Osetiya, Russia; lower Oligocene (Rupelian, Pshekha Horizon).

Diagnosis. Hyomandibular strongly inclined ventro-rostrad. First dorsal pterygiophore inserted in fourth interneural space (in other †*Palimphyes*, inserted in second or third).

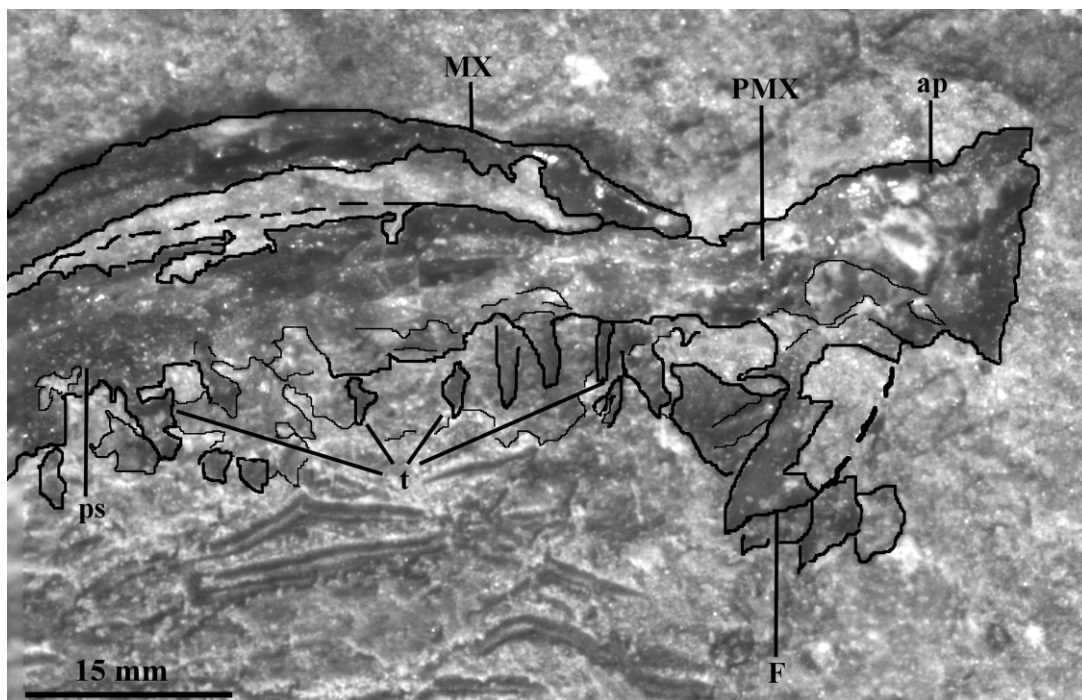

Figure 6 †*Palimphyes pshekhaensis*, PIN 4425/74, detail of dentition with clarifying interperative tracing marks; left bank of river Pshekha, N Caucasus, Russia; Bartonian. Abbreviations: ap=ascending process of premaxilla; F=fang; MX=maxilla; PMX=premaxilla; ps=posterior shank of premaxilla; t=teeth.

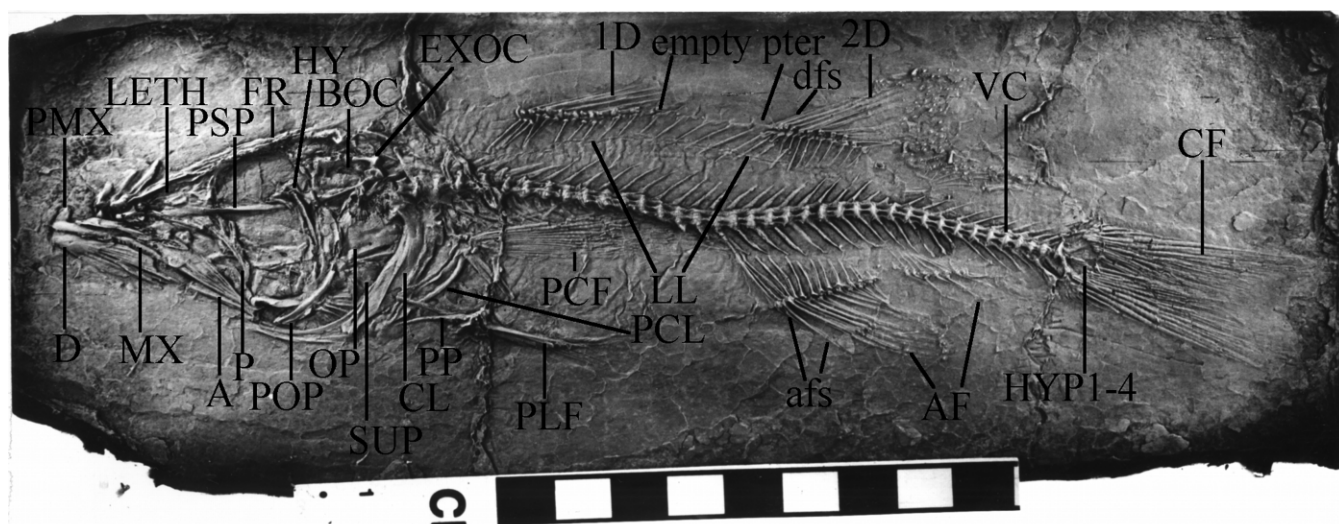

Figure 7 †*Palimphyes chadumicus*, PIN 3363/136, transfer-prepared; River Belaya, N Caucasus, Russia; Rupelian. Abbreviations: 1D=first dorsal fin; 2D=second dorsal fin; A=angular; AF=anal fin; afs=anal-fin spine; BOC=basioccipital; CF=caudal fin; CL=cleithrum; D=dentary; dfs=dorsal-fin spine; EXOC=exoccipital; FR=frontal; HY=hyomandibular; HYP=hypural; LETH=lateral ethmoid; LL=lateral line; MX=maxilla; OP=operculum; P=palatine; PCF=pectoral fin; PCL=postcleithrum; PLF=pelvic fin; PMX=premaxilla; POP=preoperculum; PP=pelvic plate; PSP=parasphenoid; pter=pterygiophores; SUP=suboperculum; VC=vertebral column.

37–39 (15–17+21–22) Vertebrae. First dorsal fin with 8–10 spines. Second dorsal fin with one anterior spine and 17–20 rays, anal fin with two spines and 17–20 rays.

Hypodigm. Two specimens from the type locality, 111 from the river Belaya (N Caucasus, Russia), five from the Pshekha River (N Caucasus), and one specimen from the Gumista River in Abkhazia. All specimens are from the Rupelian (Pshekha Horizon) and are in PIN.

Description. Maximum body depth 23–25% of standard length. Lower jaw length 56–62% of head length. More details in Danil'chenko (1960, 1967, 1980), who however gives erratic meristic counts of vertebrae and unpaired fin elements. Correct

figures are given in the current diagnosis. It should also be noted that the caudal fin has 30–34 lepidotrichia (without distinction between procurvent and principal rays).

Remarks. Bannikov & Parin (1997) indicated that †*Palimphyes longirostratus* is in need of revision. In PIN there are eight specimens of †*P. longirostratus* from the Rupelian of the deposits in the banks of the Belaya river. Morphologically, †*P. longirostratus* and †*P. chadumicus* hardly differ (if at all). Danil'chenko (1980) indicated that †*P. longirostratus* has a longer snout. A close look at the jaw apparatus of the holotype (PIN 3363/14) shows that the anterior apices of the premaxilla and the dentary have strange, bulbous deformations. These

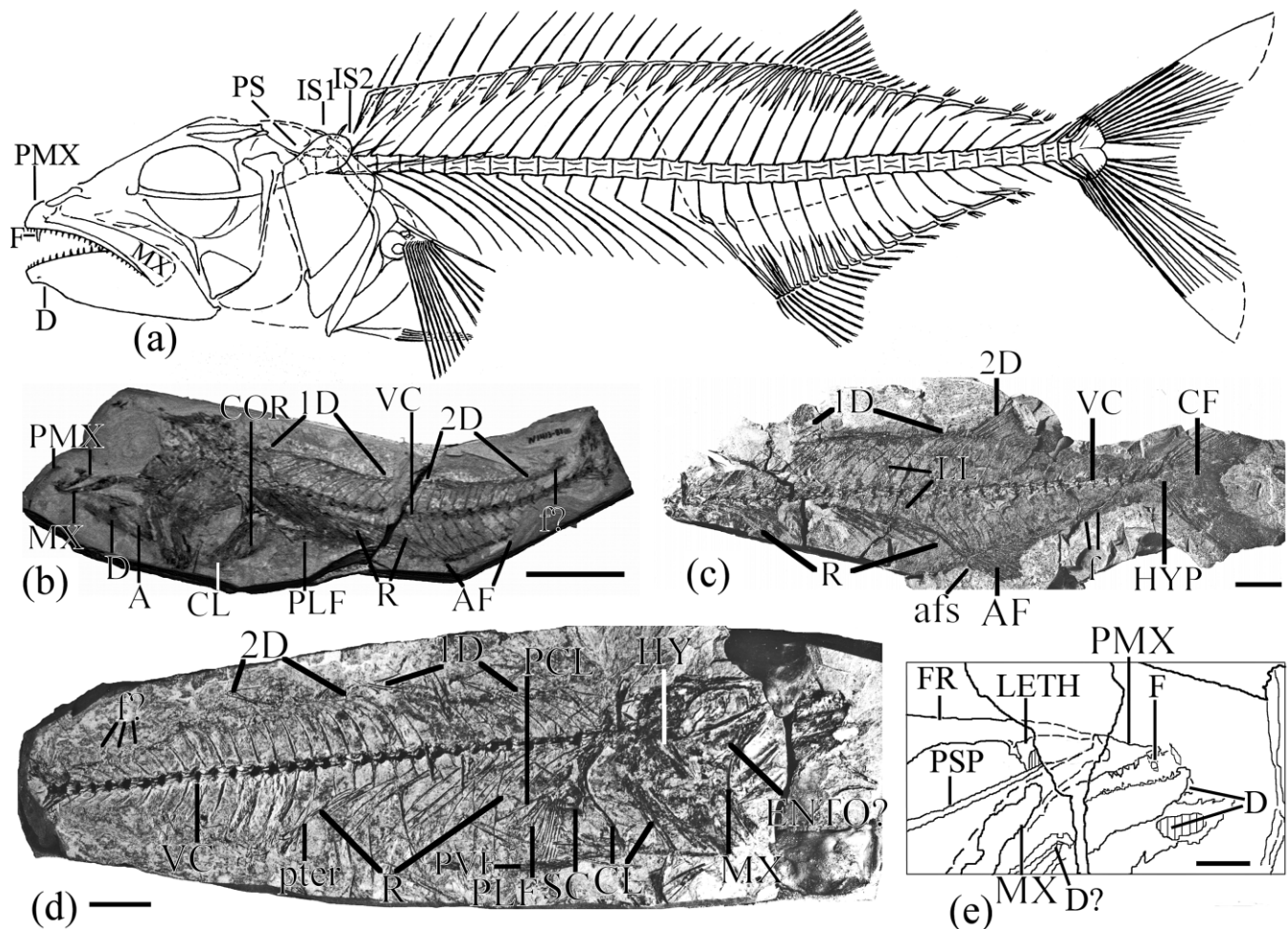

Figure 8 †*Abadzekhia marinae*, River Belaya in Abadzekhskaya village, N Caucasus, Russia; Chattian. Scale bars=20 mm unless otherwise indicated: (a) generalised reconstruction, taken from Bannikov (2010), with a few added labels (original figure without labels); (b) holotype, PIN 1413/81; (c) paratype, PIN 1413/83; (d) paratype, PIN 1413/82; (e) interpretative sketch of detail of (d), showing the premaxillary fang, scale bar=10 mm. Abbreviations: 1D=first dorsal fin; 2D=second dorsal fin; A=angular; AF=anal fin; afs=anal-fin spine; CF=caudal fin; CL=cleithrum; COR=coracoid; D=dentary; ENTO=entopterygoid; F=fang; f=finlets; FR=frontal; HY=hyomandibular; HYP=hypural; IS=interneural space; LETH=lateral ethmoid; LL=lateral line; MX=maxilla; PCL=postcleithrum; PLF=pelvic fin; PMX=premaxilla; PS=preneural space; PSP=parasphenoid; pter=pterygiophore; PVF=pelvic fin; SC=scapula; R=ribs; VC=vertebral column.

structures could be either a pathology or an artefact of fossilisation. From this morphology, it follows that the jaws of †*P. longirostratus* seem longer than they actually are and that they in fact do not differ from those in †*P. chadumicus*. Hence, †*P. longirostratus* is treated as a synonym of †*P. chadumicus* (Bannikov 2010).

Trichiuroidea *incertae sedis*
Genus †*Abadzekhia* Bannikov, 1985

Type species. †*Abadzekhia marinae* Bannikov, 1985, p. 44, by monotypy and original designation.

Diagnosis. Serial (meaning, all in premaxilla except anterior fangs) teeth slightly retrorse. One pair of premaxillary fangs, 34–35 (16–17+18) vertebrae, Dorsal pterygiophores overlap strongly to form a chain-like structure. Procurrent spur absent.

Other distinguishing characters. Body entirely covered by very thin scales. Lateral line with strong curvature near the border of abdominal and caudal parts of the vertebral column. 5–7 dorsal, and 4–7 anal finlets.

Remarks. The relationships of Recent trichiuroids in Figure 2, are poorly resolved. In this paper, hence, ‘gempylids’

and †*Abadzekhia* are ‘classified’ under *Trichiuroidea incertae sedis*.

†*Abadzekhia* is tentatively placed as the sister group of all Recent forms. It has trichiuroid apomorphies, such as the large anterior fang and the overlapping pterygiophores. It lacks apomorphies of more modern taxa, such as a reduction in number of finlets. †*Abadzekhia* is to be placed crownwards with respect to †euzaphlegids. †*Abadzekhia* is considered part of the ‘Gempylidae’ (Bannikov & Fedotov 1989; Bannikov 2005, 2010). Euzaphlegids lack typical ‘gempylid’ synapomorphies. Evidence for this placement comes from the fossil record. †*Abadzekhia* is from the Oligocene, whereas the oldest †Euzaphlegidae are from the late Palaeocene (Danil’chenko 1968, 1980). It should be stressed again that these phylogenetic relationships are tentative.

At first description, Bannikov (1985) included †*Abadzekhia* within the subfamily Scomberomorinae, family Scombridae. Reasons for that placement are the presence of finlets, a relatively deep body, and relatively few vertebrae. However, Bannikov (1985) also suspected that †*Abadzekhia* (Fig. 8a–d) is related to ‘gempylids’ or †euzaphlegids. Characters that fuelled that suspicion are the non-hypurostegic tail (which is in fact a symplesiomorphy), relatively extended soft dorsal- and anal

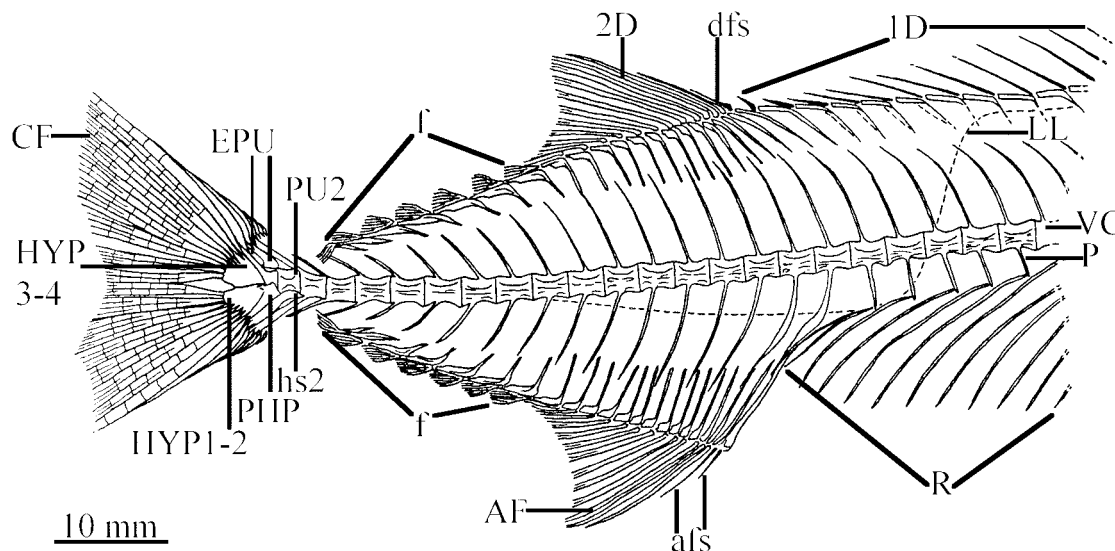

Figure 9 †*Abadzekhia tartletskovi*, holotype, PIN 3363/167, taken from Bannikov (2005), with added scale and lettering; River Pshekha, N Caucasus, Russia; Rupelian. Abbreviations: 1D=first dorsal fin; 2D=second dorsal fin; AF=anal fin; afs=anal-fin spine; CF=caudal fin; dfs=dorsal-fin spine; EPU=epural; f=finlets; hs=haemal spine; HYP=hypural; LL=lateral line; P=parapophysis; PHP=parhypural; PU=preural vertebra; R=ribs; VC=vertebral column.

fins, and the presence of a premaxillary fang (Fig. 8). Bannikov & Fedotov (1989) ascribe this genus to the 'gempylids'. Besides the presence of a fang, the affinity of †*Abadzekhia* with trichiurids seems to be confirmed by the following synapomorphies: strongly overlapping dorsal pterygiophore (see also Gago 1998) and slightly retrorse serial teeth. Most (but not all) 'gempylids' possess finlets (Nakamura & Parin 1993). †*Abadzekhia*'s scales seem to be larger than in any Recent trichiurid, a character state that is interpreted as plesiomorphic in this paper.

†*Abadzekhia tartletskovi* Bannikov, 2005
(Fig. 9)

2005 †*Abadzekhia tartletskovi* Bannikov, p. 63, fig. 2.

2010 †*Abadzekhia tartletskovi* Ban. Bannikov, p. 129, pl. XX, fig. 3, text-fig. 72.

Holotype. PIN 3363/167.

Type locality. River Pshekha, in Gorny Luch village, N Caucasus, Russia; lower Oligocene (Rupelian, Pshekha Horizon).

Diagnosis. Seven dorsal and anal finlets.

Other distinguishing characters. Second dorsal fin with one spine and 12 rays. Anal fin with two spines and 13 rays.

Hypodigm. Holotype only.

Description. See Bannikov 2005.

†*Abadzekhia marinae* Bannikov, 1985
(Fig. 8)

1980 †*Scombrostoma miatlica* Bannikov, p. 45 (*nomem nudum*).

1985 †*Abadzekhia marinae* Bannikov, p. 44, text-figs. 17c, 21, 22, pl. 5, figs. 2, 3, pl. 6, fig. 1.

1989 †*Abadzekhia marinae* Ban. Bannikov & Fedotov, p. 88, fig. 2.

1997 †*Abadzekhia marinae* Ban. Bannikov & Parin, p. 139 (name only).

1998 Scombroidei (? Gempylidae/? †Euzaphlegidae) indet. Micklich 1998, pl. III, fig. 7.

2000b †*Abadzekhia marinae* Ban. Monsch, p. 98, fig. 7.11.

2005 †*Abadzekhia marinae* Ban. Bannikov, fig. 1.

2010 †*Abadzekhia marinae* Ban. Bannikov, p. 129, pl. XXI, fig. 1, text-fig. 73.

Holotype. PIN 1413/81 (Fig. 8b).

Type locality. River Belaya in Abadzekhskaya village, N Caucasus, Russia; upper Oligocene (Chattian, Morozkina Balka Horizon).

Diagnosis. Five dorsal and four anal finlets.

Other distinguishing characters. Second dorsal fin with one spine and 13–14 rays. Anal fin with two spines and 15 soft rays.

Hypodigm. Five specimens from the type locality, and one from Abkhazia (Akhali-Afoni), all in PIN.

Description. According to the most recent reconstruction (Bannikov 2010, text-fig. 73) of this species, the first dorsal-fin spine inserts into the second interneural space (see also Fig. 8a). Dorsal fin pterygiophores are enlarged and overlap each other. This is interpreted in this paper as the modified configuration of dorsal pterygiophores as seen in trichiurids (Gago 1998). First dorsal fin with 16 or 17 spines. Pectoral fin with 14 lepidotrichia. More details in Bannikov (1985, 2010).

Remarks. Bannikov (2010) identified the caudal skeleton fragment from the Rupelian of Frauenweiler (Baden-Württemberg, Germany), classified as Scombroidei indet. by Micklich (1998), as †*Abadzekhia marinae*. The specimen is deposited in HLMD. A comparison with other specimens there confirms its identity as †*A. marinae* (see Bannikov 2010). This discovery extends the fossil record of this species back in time.

Genus *Hemithyrsites* Sauvage, 1873

Type species. †*Acanthonotos armatus* Sauvage, 1870, by monotypy.

Diagnosis. Vomerine teeth missing in adults; vertebrae 33–35; pelvic fin reduced to a single spine, or missing; two pairs of dorsal and anal finlets.

Other distinguishing characters. Anal fin with two anterior spines, both connected to fin membrane (a free first anal-fin spine, as seen among others in *Rexea*, a trichiurid genus similar to *Hemithyrsites*, is interpreted as an apomorphy). Hypurals unfused. Scale covering complete.

Remarks. We use the name *Hemithyrsites* for what is commonly called *Promethichthys* Gill, 1893. Palaeontologists

have noted that the Recent '*Promethichthys*' is identical to the fossil *Hemithyrsites* Sauvage, 1873 (Arambourg 1925; Danil'chenko 1960, 1980; Bannikov & Parin 1997; Bannikov 2010). We feel that those who employed *Hemithyrsites* as a valid name did so correctly, and yet *Promethichthys* has remained widely used by neontologists (see 34 references from the period 1952–1990 in Nakamura & Parin 1993, p. 41). At first sight, however, it seems that the International Code of Zoological Nomenclature (ICZN 1999) favours keeping the junior synonym because of frequent recent usage. Nevertheless, for maintaining such junior synonyms as valid names, two conditions should be met: (1) if a name has been employed by at least ten different authors in no less than 25 different works within the last 10–50 years, it should be maintained, despite discoveries of older valid names (ICZN 1999, art. 23.9.1.2); and (2) the senior synonym has not been used as a valid name after 1899 (ICZN 1999, art. 23.9.1.1). *Promethichthys* certainly meets the first condition, but *Hemithyrsites* does not meet the second. Even though *Hemithyrsites* has been employed only a few times recently (Danil'chenko 1960, 1980; Trelea *et al.* 1977; Bannikov & Parin 1997; Carnevale 2006; Bannikov 2010), it has been employed as a valid name after 1899. Hence, since one of the conditions for maintaining the junior synonym is not met, we propose to consider *Hemithyrsites* also as the valid name for the only Recent '*Promethichthys*', whose correct name is then *Hemithyrsites prometheus* (Cuvier in Cuvier & Valenciennes 1832). However, another, yet older name exists for *Hemithyrsites*. Monsch (2000b) accepted *Dicrotus* Günther, 1860 as the valid name of the species, based on comparisons of (type) material of *Dicrotus* and of *Promethichthys*. However, except by Monsch (2000b), the name *Dicrotus* has not been employed in the last 10–50 years. It has mostly been mentioned as a questionable synonym of *Promethichthys* (see e.g. Nakamura & Parin 1993). Hence, the name *Dicrotus* is not considered valid for this genus.

It may seem extraordinary that the name for a fossil replaces one for a Recent organism. However, there is nothing in the Code for Nomenclature that forbids this. Although such an occurrence is rare, similar cases are already known. We have found four examples of "fossil" names replacing "extant" ones. The first concerns the extant pygmy hippopotamus, which was first only known as *Choeropsis* Leidy, 1853. Coryndon (1977) considered this genus the same as the "extinct" *Hexaprotodon* Falconer & Cutley, 1836. Compagno (1984) reclassified the Recent shark *Dirrhizodon* Klunzinger, 1871 under *Hemipristis* Agassiz, 1844, which until then was only known for fossils. Another Recent shark is known under two names: *Scapanorhynchus* Woodward, 1889 and *Mitsukurina* Jordan, 1898. The older name was first given to a fossil. Woodward (1899) already regarded *Mitsukurina* a junior synonym of *Scapanorhynchus*. Lastly, the generic name *Pristigenys* Agassiz, 1835 given to a fossil priacanthid fish, is usually regarded as having priority over *Pseudopriacanthus* Bleeker, 1869. A history of its nomenclature is found in Taverne (1988).

†*Hemithyrsites maicopicus* Danil'tshenko, 1960
(Fig. 10)

- 1960 †*Hemithyrsites maicopicus* Danil'chenko, p. 140, fig. 28, pl. 13, fig. 1–2.
1964 †*Hemithyrsites maicopicus* Dan. Danil'chenko, pl. 10, fig. 7.
?1977 †*Hemithyrsites maicopicus* Dan. Trelea *et al.* 1977, p. 51, pl. III, fig. 6, pl. IV, fig. 7.
1980 †*Hemithyrsites maicopicus* Dan. Danil'chenko, p. 149.
1997 †*Hemithyrsites maicotext-figus* Bannikov & Parin, 1997, p. 140 (*typ. err.*, name only).

- 2000b †*Dicrotus maicopicus* (Dan.) Monsch, p. 95, fig. 7.9.
2010 †*Hemithyrsites maicopicus* Dan. Bannikov, p. 130, pl. XX, fig. 1.

Holotype. PIN 484/131 (part and counterpart, Fig. 10).

Type locality. Kurdzhips River, Adygea, N Caucasus, Russia; lower Miocene (upper Maykopian, Aquitanian/Burdigalian, see Popov *et al.* (1993b).

Diagnosis. Seventeen caudal vertebrae (up to 16 in the Recent *Hemithyrsites prometheus*, see Nakamura & Parin 1993). Pelvic-fin spines of juvenile reduced in size (see Remarks).

Other distinguishing characters. Sixteen precaudal vertebrae (18–20 in *H. prometheus*, see Nakamura & Parin 1993). First dorsal fin with 17 spines. Second dorsal fin with one spine and 17–18 rays (I+17–20 in *H. prometheus*, see Nakamura & Parin 1993).

Hypodigm. Holotype only.

Description. †*Hemithyrsites maicopicus* was described in detail by Danil'chenko (1960, 1967, 1980). Corrections to those descriptions and new observations are given in the current diagnosis, under the other distinguishing characters and in this section. Standard length 53 mm, total length 59 mm. Anal fin with two spines and 16 soft rays. Pterotic a short winged structure. Caudal fin with 25 lepidotrichia, including 17 principal rays. Pelvic-fin spine longer than posterior process of pelvic plate. Proximal–middle radial and distal radial of soft dorsal fin pterygiophores overlap extensively; distal radial locks snugly on process of proximal–middle radial.

Remarks. The known specimen of this species is a sub-adult, judging by its size and comparatively large and serrated pelvic-fin spines (Fig. 10b). In the smallest adult *Hemithyrsites*, pelvic-fin spines are smaller and inconspicuous; in adults larger than 400 mm standard length (the maximum known size is 1 m), a pelvic-fin spine is missing altogether (Nakamura & Parin 1993). In juvenile specimens of *H. prometheus*, e.g. BMNH 1953.12.31.5 (the type of *Dicrotus armatus* Günther, 1860; a juvenile specimen), of 58 mm fork length, the pelvic-fin spine is as long as the maximum body depth and serrated. The pelvic spines of juvenile 'gempylids' are large and serrated (Collette *et al.* 1984; Johnson 1986). Although the holotype of *H. maicopicus* is smaller than the type of *D. armatus*, the pelvic-fin spines of the fossil are absolutely and relatively smaller than in the Recent juvenile, which is interpreted as an apomorphic further reduction in size. It is remarkable that in the juvenile *H. prometheus* finlets are not yet developed, whereas they can already be discerned in *H. maicopicus*.

Trelea *et al.* (1977) recorded *P. maicopicus* from the Oligocene of Romania based on a single incomplete specimen (posterior part of the skeleton) that in fact does not possess all relevant apomorphies, and hence its identification is doubtful.

Genus †*Argestichthys* Prokofiev, 2002

Type species. †*Argestichthys vysotzkyi* Prokofiev, 2002, p. 230, by original designation and monotypy.

Diagnosis. Barbed serial teeth and large barbed fangs. Supraoccipital crest reduced in size. Lateral line with two close, almost completely parallel lines close to dorsal fins, one of which originating from nape, another at level of the 11th dorsal-fin spine. First pterygiophore of first dorsal fin in preneural space. Haemal spine 1 widened (see Fig. 11), first two pterygiophores of anal fin inserted anterior of haemal spine 1 and apparently associated with ribs (see Fig. 11a).

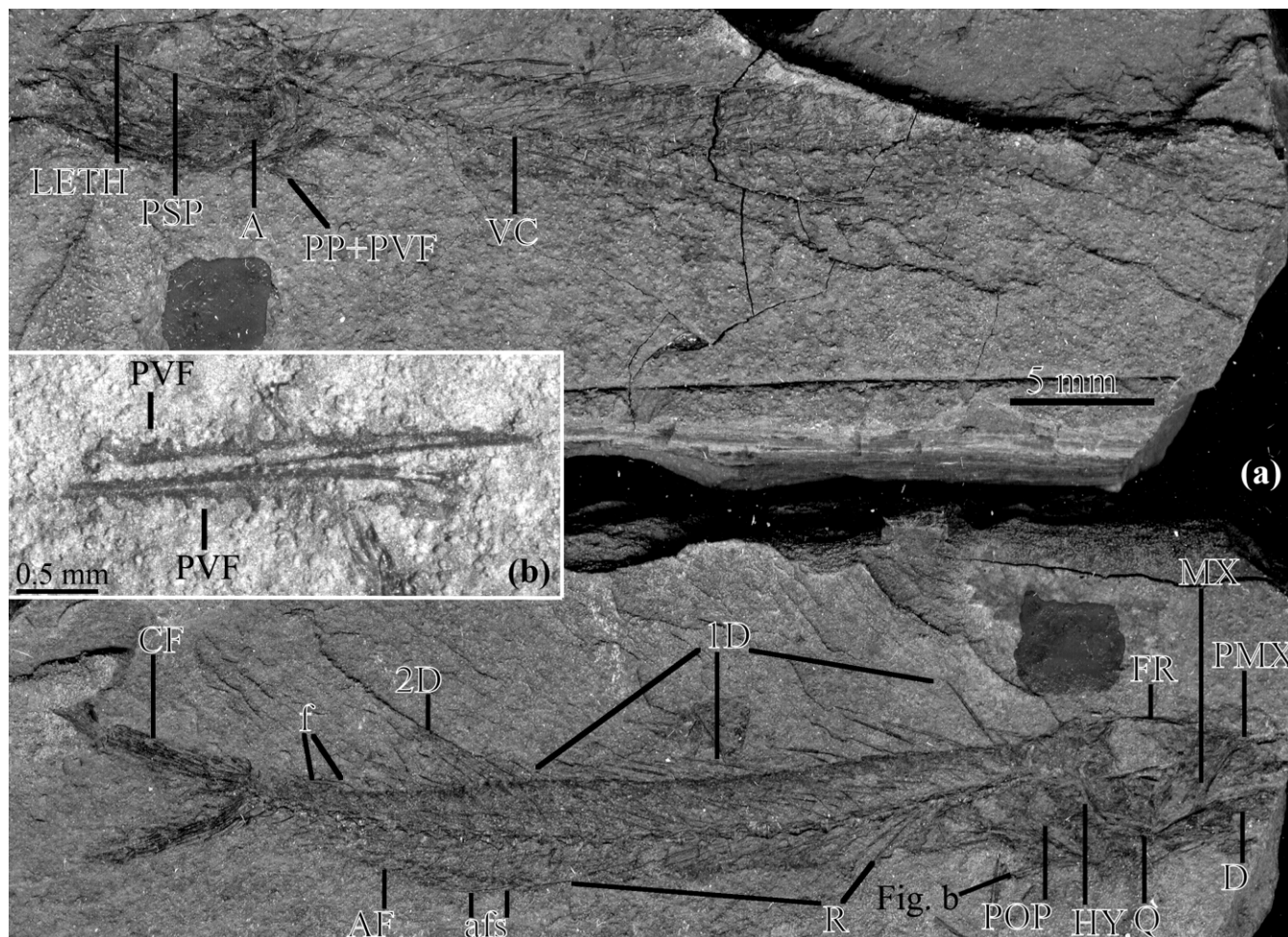

Figure 10 †*Hemithyrstes maicopicus*, holotype, PIN 484/131, part and counterpart; River Kurdzhips, N Caucasus, Russia; Aquitanian/Burdigalian: (a) complete views of counterparts; (b) detail of counterpart with snout pointing to right, proximal end of PVF at the right. Abbreviations: 1D=first dorsal fin; 2D=second dorsal fin; A=angular; AF=anal fin; afs=anal-fin spine; CF=caudal fin; D=dentary; f=finlets; FR=frontal; HY=hyomandibular; LETH=lateral ethmoid; MX=maxilla; PMX=premaxilla; POP=preoperculum; PP=pelvic plate; PSP=parasphenoid; PVF=pelvic fin; Q=quadrate; R=ribs; VC=vertebral column.

Other distinguishing characters. Body relatively deep and short, sclerotics present, precaudal vertebrae about 15, caudal vertebrae 20, operculum without spines, pelvic plate and pelvic fin large, first anal-fin spine not reduced and/or dagger-shaped, first anal-fin pterygiophore with single supernumerary spine, body scale covering complete.

Remarks. The characters for diagnosing and differentiating the genus are taken from Prokofiev (2002), even though our interpretations of which characters are diagnostic and which only differentiate differ. Besides that, we do not believe that †*Argestichthys* can be diagnosed by teeth that are ‘not fixed’ in place. Loose teeth are likely to be an artefact of fossilisation. This is the only known trichiurid in which both anterior fangs and serial teeth are barbed.

Prokofiev (2002) recognised that †*Argestichthys* shares synapomorphies with *Ruvettus* and an apomorphic terminal clade of trichiurids, while it simultaneously lacks key apomorphies that define the family Trichiuridae. He ultimately hypothesised that the genus is a primitive sister group to trichiurids. We can only tentatively agree with this placement (Fig. 2). Considering the mosaic of apomorphic and plesiomorphic characters, the phylogenetic position of †*Argestichthys* cannot be inferred with a great degree of confidence without a thorough phylogenetic analysis. A radiographed specimen of *Ruvettus* (BMNH 1938.623.24) suggests that this genus displays a variety in characters that Prokofiev (2002) was not familiar

with. Prokofiev considered that *Ruvettus* also has two anal-fin pterygiophores inserted anterior of haemal spine 1. In our radiographed specimen, only one pterygiophore is inserted anterior of haemal spine 1, but not in an ‘abdominal position’ (Prokofiev 2002); the pterygiophore is loosely connected to haemal spine 1. These considerations weaken the hypothesis that †*Argestichthys* is closely related to *Ruvettus*.

†*Argestichthys vysotzkyi* Prokofiev, 2002
(Fig. 11)

2002 †*Argestichthys vysotzkyi* Prokofiev, p. 230, figs. 1–6.
2010 †*Argestichthys vysotzkyi* Prok. Bannikov, p. 128, pl. XIX,
fig. 2.

Holotype. PIN 4782/94.

Type locality. 2 km NE of Uilya-Kushlyuk, Turkmenistan; upper Palaeocene (Thanetian, upper part of Danata Svita).

Diagnosis and other distinguishing characters. As for genus.

Hypodigm. The holotype and eleven specimens from the type locality, in PIN.

Description. ≥14 Spines in first dorsal fin. Second dorsal fin with 17 soft rays. Anal fin with two spines and 12 soft rays. See also remarks for genus †*Argestichthys* above. More details in Prokofiev (2002).

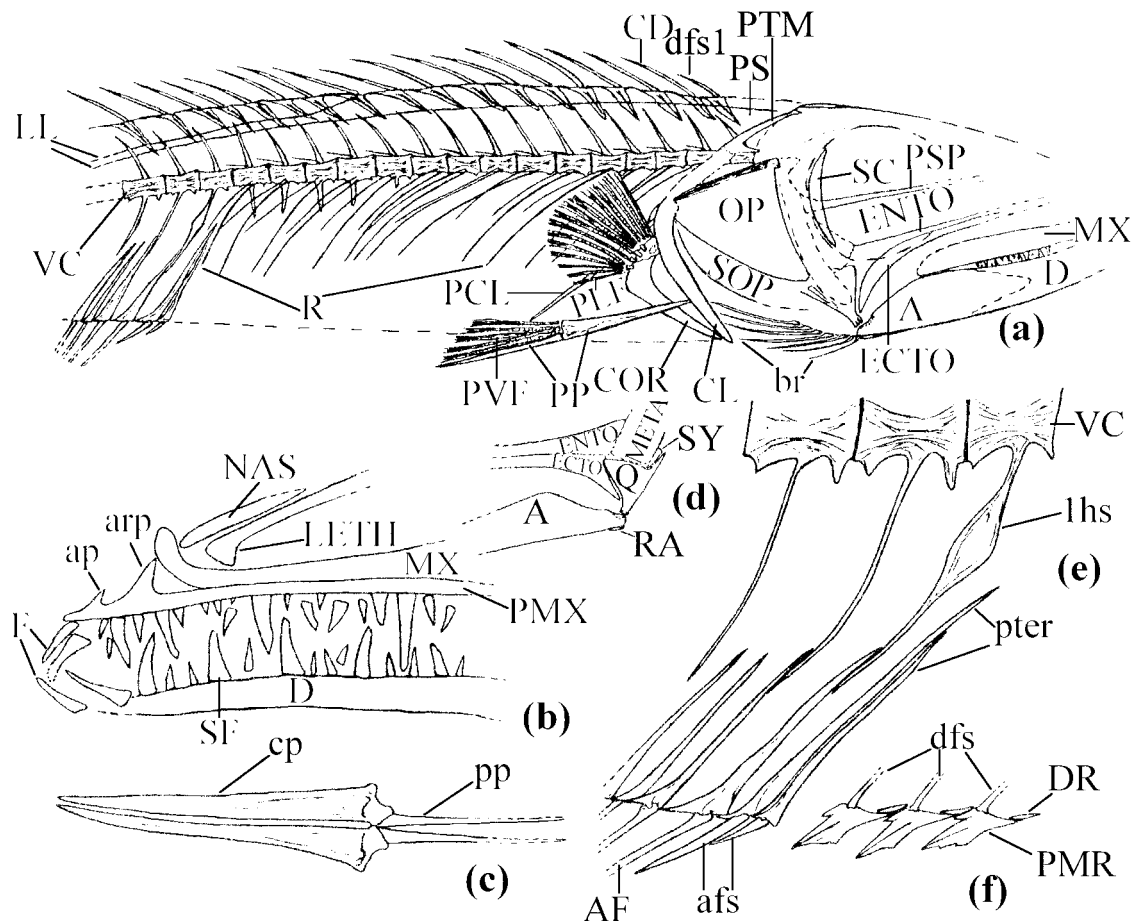

Figure 11 †*Argostichthys vysotzkyi*, Uilya-Kushlyuk, Turkmenistan; Thanetian, taken from Prokofiev (2002) with modified labelling (original also lacks scales): (a) reconstruction (based mostly on holotype PIN 4782/94 as well as on paratypes PIN 4782/95, 96); (b) jaws of juvenile PIN 4782/97; (c) pelvic plate (based on holotype and paratypes PIN 4782/95, 96); (d) angular and part of suspensorium (based on paratypes 4782/96, 97); (e) anterior haemal spines and anal pterygiophores (based on paratypes PIN 4782/95, 98); (f) dorsal-fin pterygiophores and spines (based on holotype). Abbreviations: lhs=first haemal spine; A=angular; AF=anal fin; afs=anal-fin spine; ap=ascending process of premaxilla; arp=articulatory process of premaxilla; br=branchiostegal ray; CD=continuous dorsal fin; CL=cleithrum; COR=coracoid; cp=part of pelvic plate; D=dentary; dfs=dorsal-fin spine; DR=distal radial of pterygiophore; ECTO=ectopterygioid; ENTO=entopterygioid; F=(anterior) fang; LETH, lateral ethmoid; LL=lateral line; META=metapterygioid; MX=maxilla; NAS=nasal; OP=operculum; PCL=postcleithrum; PLF=pelvic fin; PMR=proximal-middle radial of pterygiophore; PMX=premaxilla; PP=pelvic plate; pp=posterior process of pelvic plate; PS=preneural space; PSP=parasphenoid; pter=pterygiophore; PTM=posttemporal; PVF=pelvic fin; Q=quadrate; R=ribs; RA=retroarticular; SC=sclerotic; SF=serial fang; SOP=suboperculum; SY=symplectic; VC=vertebral column.

Family Trichiuridae Rafinesque-Schmaltz, 1810
Genus †*Anencheum* de Blainville, 1818

Type species. †*Anencheum glarisanum* de Blainville, 1818, p. 314, by monotypy.

Diagnosis. Pelvic fin reduced to only a single spine (in trichiurids there is an evolutionary trend of reduction of this fin: there are species known with complete pelvic fins to species with a vestigial, or with no fin; see Gago 1998).

Other distinguishing characters. 27–50 hard dorsal-fin spines, caudal complex with caudal fin present (reduced in some species), not every pterygiophore of soft part of dorsal fin articulating with neural spines: some projecting loosely into corresponding interneural space (some trichiurids with synapomorphy in which every such pterygiophore articulating with a neural spine, see Tucker 1956). 76–124 vertebrae. These are plesiomorphies of trichiurids (see Nakamura & Parin 1993; Gago 1998).

Remarks. Since Wettstein (1886) all authors treated †*Anencheum* as a junior synonym of *Lepidopus* (e.g. Woodward 1901; Danil'chenko 1960, 1962, 1980), until Bannikov & Parin's (1995) review of the defining characteristics of the

genus. From their study, it follows that †*Anencheum* is a separate taxon. They remarked that †*Anencheum* is a primitive member of the subfamily Aphanopinae, even though it also shares characters with subfamily Lepidopinae, and some of the characters that it shares with *Lepidopus* are admittedly symplesiomorphies. However, based on the morphological cladistic studies of Gago (1997, 1998), the traditional tripartition of Trichiuridae into subfamilies Trichiurinae, Lepidopinae and Aphanopinae is to be abandoned. The topology of Gago's cladograms is such that trichiurids cannot be subdivided into strictly separated subfamilies. In Gago (1997, 1998), *Aphanopus* appeared as the sister taxon of all other Recent trichiurids. †*Anencheum* were also included in Monsch's (2000b) phylogenetic analysis, from which it follows that †*Anencheum* is the sister group of all other, fossil and Recent, trichiurids. In Monsch's (2000b) cladogram, the trichiurids were arranged as follows: (†*Anencheum* (*Aphanopus* (other trichiurids))), which confirms the hypothesis of Bannikov & Parin (1995), in which †*Anencheum* is an early branch within Trichiuridae. Within the territories of the former USSR, †*Anencheum* is represented by the five species described below.

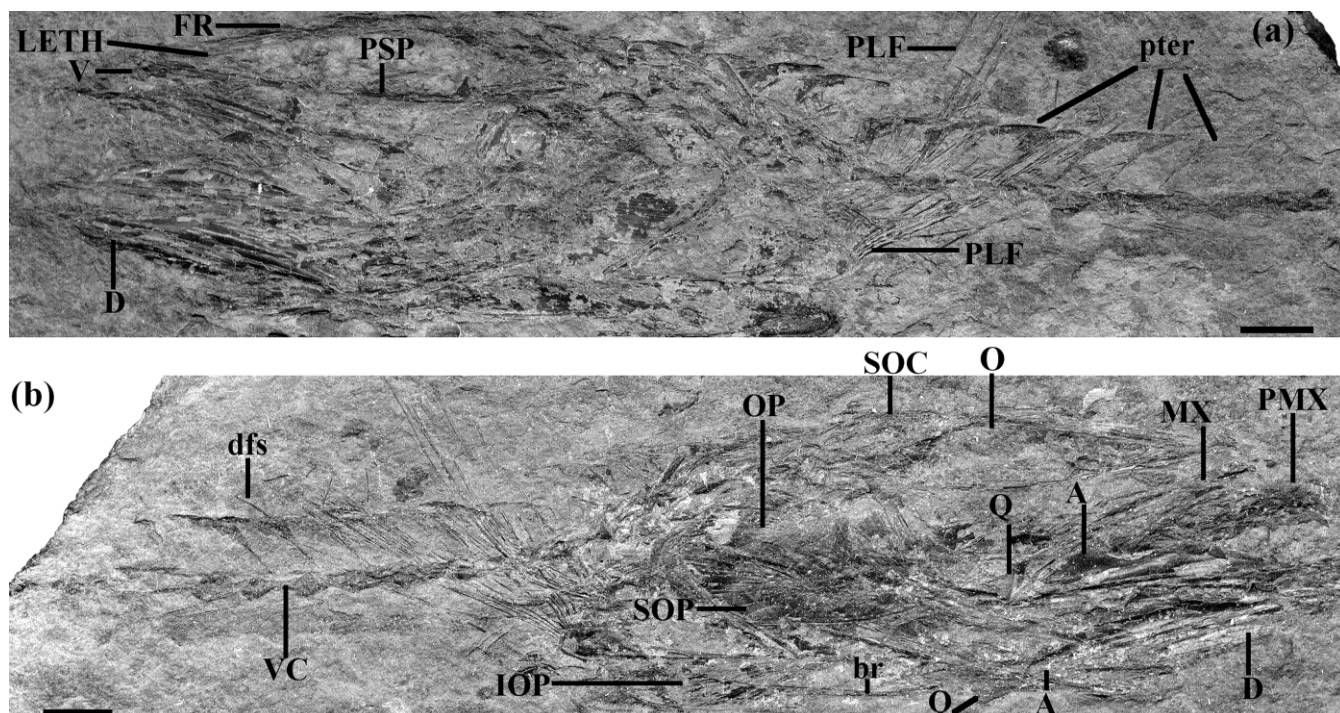

Figure 12 †*Anenichelum eocaenicum*, holotype, PIN 1413/78, part and counterpart; Dabakhana Gorge, near Tbilisi, Georgia; Lutetian. Scale bars=5 mm. Abbreviations: A=angular; br=branchiostegal ray; D=dentary; dfs=dorsal-fin spine; FR=frontal; IOP=interoperculum; LETH=lateral ethmoid; MX=maxilla; O=orbit; OP=operculum; PLF=pelvic fin; PMX=premaxilla; PSP=parasphenoid; pter=pterygoid; Q=quadrate; SOC=supraoccipital crest; SOP=suboperculum; V=vomer; VC=vertebral column.

†*Anenichelum eocaenicum* (Daniltshenko, 1962)
(Fig. 12)

1962 †*Lepidopus eocaenicus* Danil'chenko, p. 121, text-fig. 19.

1980 †*Lepidopus eocaenicus* Dan. Danil'chenko, p. 145.

1993d †*Lepidopus eocaenicus* Dan. Bannikov, p. 243 (name only).

1995 †*Anenichelum eocaenicum* Dan. Bannikov & Parin, p. 184 (name only).

1997 †*Anenichelum eocaenicum* Dan. Bannikov & Parin, p. 135 (name only).

2000b Unknown, Monsch, p. 88 (name only).

2010 †*Anenichelum eocaenicum* Dan. Bannikov, p. 131, text-fig. 74.

Holotype. PIN 1413/78.

Type locality. Dabakhana Gorge, near Tbilisi, Georgia; Dabakhana Svita, middle Eocene (Lutetian?).

Diagnosis. Fifty-four caudal vertebrae, which is a relatively high number (from the fragmentary nature of the material the total number of vertebrae cannot be assessed, nor a minimum count be given).

Other distinguishing characters. Lower jaw articulation at middle of orbit. Soft part of dorsal fin short: first soft dorsal-fin ray projecting well into caudal part of vertebral column. First dorsal-fin pterygiophore that is not connected to neural spine is of first soft dorsal-fin ray (Bannikov & Parin 1995).

Hypodigm. Eight specimens from the type locality in the collection of PIN.

Description. Head length 2.3 to 2.4 times greater than body depth. More details in Danil'chenko (1962, 1980).

†*Anenichelum paucivertebrale* Bannikov & Parin, 1995
(Fig. 13)

1993d *Lepidopus* sp. Bannikov, p. 245, fig. 3B.

1995 †*Anenichelum paucivertebrale* Bannikov & Parin, p. 187, figs. 1–3.

1997 †*Anenichelum paucivertebrale* B. & P. Bannikov & Parin, p. 135 (name only).

2000b †*Anenichelum paucivertebrale* B. & P. Monsch, 2000b, p. 90, fig. 7.5.

2010 †*Anenichelum paucivertebrale* B. & P. Bannikov, p. 132, pl. XXI, fig. 3, text-fig. 75.

Holotype. PIN 4425/23.

Type locality. Left bank of the Pshexha River, 1 km from Gorny Luch, SW Russia (N Caucasus); middle Eocene (Bartonian, Kuma Horizon).

Diagnosis. 76 (31–32+44–45) vertebrae. Long soft dorsal fin: first pterygiophore that is not connected to neural spine is situated toward end of precaudal part of vertebral column (Fig. 13a). In other species, first 'irregular' dorsal pterygiophore inserted in caudal part of vertebral column.

Other distinguishing characters. Articulation of the lower jaw with quadrate under middle of orbit. Perhaps two anal-fin spines (first anal-fin spine often reduced in trichiurids, see Nakamura & Parin 1993). Presence of only large dagger-shaped anal-fin spine, similar to a second unreduced anal-fin spine (Fig. 13b) can be confirmed.

Hypodigm. Thirty-five specimens from the type locality, in PIN.

Description. Anal fin with 35–36 soft rays. Head length 14–15% of standard length. More details in Bannikov & Parin (1995). Based on new observations, it is difficult to state an exact number of pectoral fin rays, although there seem to be 12. Soft part of dorsal fin with 44 rather than 43 rays.

†*Anenichelum glarisianum* de Blainville, 1818

1818 †*Anenichelum glarisianum* de Blainville, p. 314.

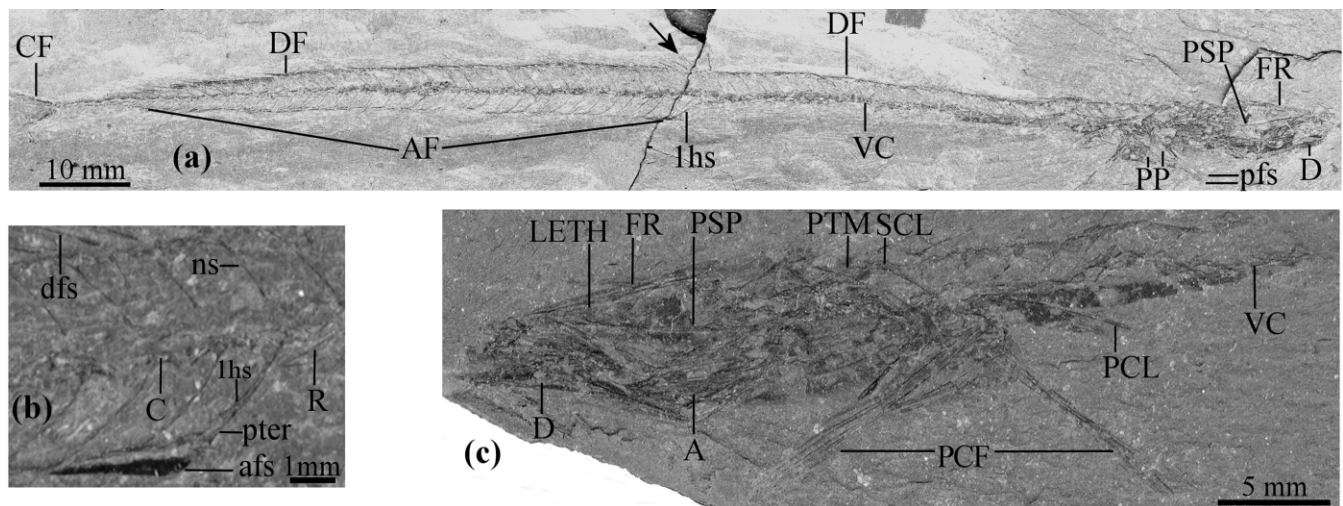

Figure 13 †*Anenichelum paucivertebrale*, Pshekha River, 1 km from Gorny Luch, N Caucasus, Russia; Bartonian: (a) part of holotype, PIN 4425/23, with arrow indicating first 'irregular' dorsal-fin pterygiophore; (b) detail of paratype PIN 4425/24, showing the enlarged anal-fin spine; (c) counterpart of holotype. Abbreviations: A=angular; AF=anal fin; afs=anal-fin spine; C=centrum; CF=caudal fin; D=dentary, DF=dorsal fin; dfs=dorsal-fin spine; FR=frontal; hs=haemal spine; LETH=lateral ethmoid; ns=neural spine; PCF=pectoral fin; PCL=postcleithrum; pfs=pelvic-fin spine; PP=pelvic plate; PSP=parasphenoid; pter=pterygoid; PTM=posttemporal; R=ribs; SCL=supracleithrum; VC=vertebral column.

- 1834 †*Anenichelum heteropleurum* Agassiz, p. 132 (*nomen nudum*).
- 1834 †*Anenichelum glarisianum* de Bl. Agassiz, p. 302 (name only).
- 1834 †*Anenichelum latum* Agassiz, p. 302 (*nomen nudum*).
- 1834 †*Anenichelum isopleurum* Agassiz, p. 302 (*nomen nudum*).
- 1833–44 †*Anenichelum glarisianum* de Bl. Agassiz, p. 70, pl. 37, figs. 1, 2.
- 1833–44 †*Anenichelum isopleurum* Agassiz, p. 71, pl. 37, fig. 3.
- 1833–44 †*Anenichelum dorsale* Agassiz, p. 72, pl. 37, fig. 4, pl. 37a, figs. 1, 2.
- 1833–44 †*Anenichelum heteropleurum* Agassiz, p. 73, pl. 37a, fig. 3.
- 1833–44 †*Anenichelum latum* Agassiz, p. 74, pl. 36.
- 1847 †*Anenichelum breviceps* Giebel, p. 665.
- 1850 †*Lepidopides leptospondylus* Heckel, p. 240, pl. 22.
- 1850 †*Lepidopides dubius* Heckel, p. 241.
- 1850 †*Lepidopides brevispondylus* Heckel, p. 241, pl. 27.
- 1859 †*Anenichelum glarisianum* de Bl., vom Rath, p. 122, pl. 3, fig. 5.
- 1859 †*Anenichelum latum* Ag. vom Rath, p. 122, pl. 3, fig. 6, pl. 4.
- 1859 †*Anenichelum dorsale* Ag. vom Rath, p. 122, pl. 3, fig. 8.
- 1859 †*Anenichelum isopleurum* Ag. vom Rath, p. 123.
- 1859 †*Anenichelum heteropleurum* Ag. vom Rath, p. 123.
- 1867 †*Anenichelum latum* Ag. Winkler, p. 633 (name only).
- 1867 †*Anenichelum glarisianum* de Bl. Winkler, p. 633 (name only).
- 1867 †*Anenichelum heteropleurum* Ag. Winkler, p. 633 (name only).
- 1867 †*Anenichelum dorsale* Ag. Winkler, p. 634 (name only).
- 1879 †*Lepidopus dubius* Heck. Kramberger, p. 55, Pl. 14.
- 1879 †*Lepidopus carpathicus* Kramberger, p. 57, Pl. 16, fig. 1.
- 1879 †*Lepidopus leptospondylus* Heck. Kramberger, p. 57.
- 1886 †*Lepidopus glaronensis* Wettstein, p. 42, pl. 5, figs 1, 3, 5, 9, 10; pl. 6, figs 1, 3, 5–8.
- 1901 †*Lepidopus glarisianus* (de Bl.) Woodward, p. 477.
- 1928 †*Lepidopus glarisianus* (de Bl.) Weiler, p. 32, pl. 2, fig. 5.
- 1929a †*Lepidopus glarissianus* [sic] (de Bl.) Paucă, p. 116.
- non1929c *Lepidopus caudatus* (Euphr.) Paucă, p. 209.
- non1930 *Lepidopus caudatus* (Euphr.) Paucă, p. 179.
- 1934 †*Lepidopus glarisianus* (de Bl.) Paucă, p. 615, pl. 3, fig. 3.
- 1934 †*Lepidopus glarisianus* (de Bl.) Théobald, p. 145, pl. 11, fig. 3, pl. 14, fig. 2.
- non1958 *Lepidopus caudatus* (Euphr.) Jerzmańska, p. 179.
- 1960 †*Lepidopus glarisianus* (de Bl.) Danil'chenko, p. 143 (*pro parte*).
- 1968 †*Lepidopus glarisianus* (de Bl.) Jerzmańska, p. 463, text-fig. 23, pl. 7.
- 1974 †*Lepidopus dubius* Heck. Pharissat, p. 45.
- 1980 *Lepidopus* Clerget, p. 12.
- 1980 †*Lepidopus glarisianus* (de Bl.) Danil'chenko, p. 150 (*pro parte*).
- 1990 †*Lepidopus glarissianus* [sic] (de Bl.) Pharissat, p. 86.
- 1991 †*Lepidopus glarisianus* (de Bl.) Pharissat, p. 60, figs. 47, 49, 50.
- 1995 †*Anenichelum glarisianum* de Bl. Bannikov & Parin, p. 183 (name only).
- 2000b †*Anenichelum glarisianum* de Bl. Monsch, p. 88, fig. 7.4.
- non2000b †*Anenichelum glarisianum* de Bl. Monsch, p. 89 (*pro parte* = *A. angustum* Danil'chenko, 1980).
- 2002 †*Anenichelum glarisianum* de Bl. Żabrowski, p. 37 (name only).
- 2006 †*Anenichelum glarisianum* de Bl. Żabrowski, p. 112 (name only).
- 2010 †*Anenichelum glarisianum* de Bl. Bannikov, p. 133, pl. XXII, fig. 1.

Lectotype. Woodward (1901) indicated the type as an 'imperfect fish', without further information. The lectotype is the specimen figured in Scheuchzer (1708, pl. II).

Type locality. Engi, Canton Glarus, Switzerland; lower Oligocene (Rupelian, Glarner Schiefer).

Diagnosis. Vertebrae 108–120 (35–40+73–80). Dorsal fin with 98–104 rays, of which first ca. 40 spinous. Anal fin with 67–73 soft rays (of which the first ca. 45 are shortened and barely visible, but the beginning of the anal fin can be observed by its anterior spines).

Other distinguishing characters. Two anal-fin spines clearly developed. Lower jaw articulation under middle of orbit.

Specimens. The hypodigm is too large and too scattered around various institutions to be calculated exactly. The majority of the specimens come from the type locality, at least 47 specimens of which are kept at BMNH (Woodward 1901;

Monsch 2000b) and 17 at TM (Winkler 1867). †*Anencheilus glarisianus* is, however, also known from other Oligocene territories, in, e.g., Poland – 92 specimens in ZPaWr (Jerzmańska 1968; Żabrowski 2002). From former Soviet Union territories there are seven specimens, in PIN from Rupelian sediments: five from Gumista, Abkhazia (Pshekha Horizon), one from Lubizhnya and one from the Pistyn River, both W Ukraine. These specimens were studied for this paper.

Description. Detailed descriptions of specimens of †*A. glarisianus* from territories formerly of the USSR were given by Danil'chenko (1960, 1967 (in English), 1980). The most recent, well-accessible, description is Pharissat (1991), who drew heavily from Jerzmańska (1968). Additional and/or corrected information, obtained from specimens in PIN, is given below. Ventral margin of suboperculum convex. Pectoral fin with 11 rays. Caudal skeleton with two epurals. Hypurals 1–2 and 3–4 respectively fused together. About 30 caudal-fin rays, including 17 principal lepidotrichia. First dorsal pterygiophore inserted in first interneural space. Head length 12–13% of standard length.

Remarks. Pharissat (1991) reported a juvenile specimen that possesses three anal-fin spines. This condition cannot be confirmed from the specimens studied in PIN. A figure of †*A. glarisianus* is not provided in this present paper, but there are many pictures of this species available (see synonymy above).

†*Anencheilus angustum* (Danil'tshenko, 1980)
(Fig. 14)

- 1933 †*Lepidopus* sp. ? ex gr. *glarisianus* (de Bl.) Bogachev, p. 20, pl. 2, figs. 1–3, 5, 6.
1933 †*Lepidopus leptospondylus* (Heck.) Bogachev, p. 22, pl. 1, fig. 1.
1933 †*Lepidopus glarisianus* (de Bl.) Bogachev, p. 23, pl. 2, fig. 7, 8.
1949 †*Lepidopus leptospondylus* (Heck.) Menner & Ryabinin, p. 311, pl. 87, fig. 1.
1960 †*Lepidopus glarisianus* (de Bl.) Danil'chenko, p. 143, text-fig. 29, pl. 14, figs. 1, 2.
1960 †*Lepidopus glarisianus* (de Bl.) Aslanova, p. 80, figs. 4, 5.
1964 †*Lepidopus glarisianus* (de Bl.) Danil'chenko, pl. 9, fig. 1.
1980 †*Lepidopus glarisianus* (de Bl.) Danil'chenko, p. 150 (*pro parte*).
1980 †*Lepidopus angustus* Danil'chenko, p. 151, pl. 7, figs. 1, 2.
1988 †*Lepidopus angustus* Dan. Dzhafarova, p. 3, figs. 1, 2, 4–6.
1995 †*Anencheilus angustum* (Dan.) Bannikov & Parin, p. 184 (name only).
1997 †*Anencheilus angustum* (Dan.) Bannikov & Parin, p. 137 (name only).
non2000b †*Anencheilus glarisianus* (Dan.) Monsch, p. 89 (*pro parte*).
2010 †*Anencheilus angustum* (Dan.) Bannikov, p. 132, pl. XXI, fig. 4.

Holotype. PIN 1413/94 (Fig. 14a).

Type locality. River Belaya, N Caucasus, Russia; lower Oligocene (Rupelian, Khadum deposits).

Diagnosis. Articulation of lower jaw with quadrate posterior to middle of orbit. Vertebrae 116–121 (45–47+71–74). Dorsal fin with of 46–48 anterior spines and 70–75 rays. Anal fin with 65–67 rays.

Other distinguishing characters. Only one anal-fin spine found. From our material it is not clear whether the species possess a first reduced anal-fin spine.

Hypodigm. One hundred and forty-six specimens from the type locality, 16 from the river Pshekha, N Caucasus, one from

the Morozkina Ravine (Krasnodar Region), one from the Kuban River, N Caucasus, and one from the Apsheron peninsula, Azerbaijan; lower Oligocene, Rupelian (Pshekha Horizon). All specimens are in PIN.

Description. Head length 14–15% of standard length. More details in Danil'chenko (1980).

Remarks. This species has repeatedly been confused with †*A. glarisianus* (see synonymy list above). The species are known from the same age and are very much alike, especially in their vertebral count. There is, however, a differences in the number of precaudal vertebrae (†*A. glarisianus* 35–40, †*A. angustum* 45–47). Differences can be found furthermore in the fin ray counts: †*A. angustum* has more numerous dorsal-fin elements, because of higher counts of both spines and rays (see diagnoses above). Besides that, specimens that can be attributed with certainty to either †*A. glarisianus* or †*A. angustum* have been found in strictly separated, non-overlapping territories.

†*Anencheilus lednevi* (Menner, 1949)
(Fig. 15)

- non1914 †*Lepidopus albyi* (Sauvage, 1870) Lednev, p. 11, pl. 3, fig. 10.
1933 †*Lepidopus* sp.? Bogachev, 1933, p. 22, pl. 2, fig. 4.
1949 †*Lepidopus lednevi* Menner, p. 359, pl. 81, fig. 1.
1995 †*Anencheilus lednevi* (Men.) Bannikov & Parin, p. 184 (name only).
1997 †*Anencheilus lednevi* (Men.) Bannikov & Parin, p. 140 (name only).
2010 †*Anencheilus lednevi* (Men.) Bannikov, p. 134, pl. XXI, fig. 2.

Holotype. Location unknown. Original image reproduced with our labels in Figure 15.

Type locality. Suburb of Baku, Apsheron peninsula, Azerbaijan; lower Miocene (lower Burdigalian, Sakaraul Horizon).

Diagnosis. First pterygiophore of soft portion of dorsal fin inserted into 5th–7th interneural space of caudal part of vertebral column (i.e. further caudally inserted than in other species). 99–100 (36–37+63) vertebrae. 43–44 Dorsal-fin spines, number of dorsal-fin rays unknown.

Hypodigm. Besides the holotype, only two specimens are known: one from Apsheron peninsula, Azerbaijan and one from Voskovaya Mount in the Krasnodar Region of Russia, from the same strata and age as the holotype. All specimens are in PIN.

Description. Head length 12–13% of standard length. More details in Lednev (1914, pl. 3, fig. 10).

Genus *Lepidopus* Goüan, 1770

Type species. *Lepidopus gouanianus* Lacépède, 1800 (= *Trichiurus caudatus* Euphrasen, 1788, p. 52), by subsequent monotypy or subsequent designation.

Diagnosis. Large sagittal crest. 82–114 vertebrae. Dorsal fin with 78–110 elements, of 7–10 flexible spines, remaining elements are soft rays. 41–66 Anal-fin rays. Pelvic fin reduced to one spine with one or two rays.

Other distinguishing characters. Caudal fin present, comparatively large eye near dorsal contour of head, posterior margin of Suboperculum convex, two anal-fin spines.

†*Lepidopus lateralis* Danil'tshenko, 1980
(Fig. 16)

- 1980 †*Lepidopus lateralis* Danil'chenko, p. 152, pl. 8, figs. 1, 2.

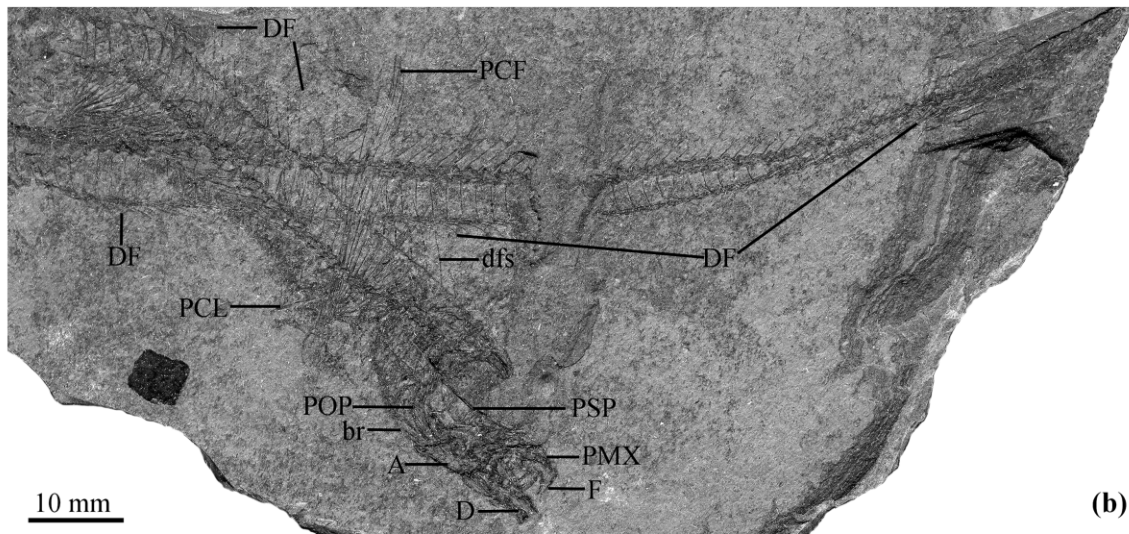
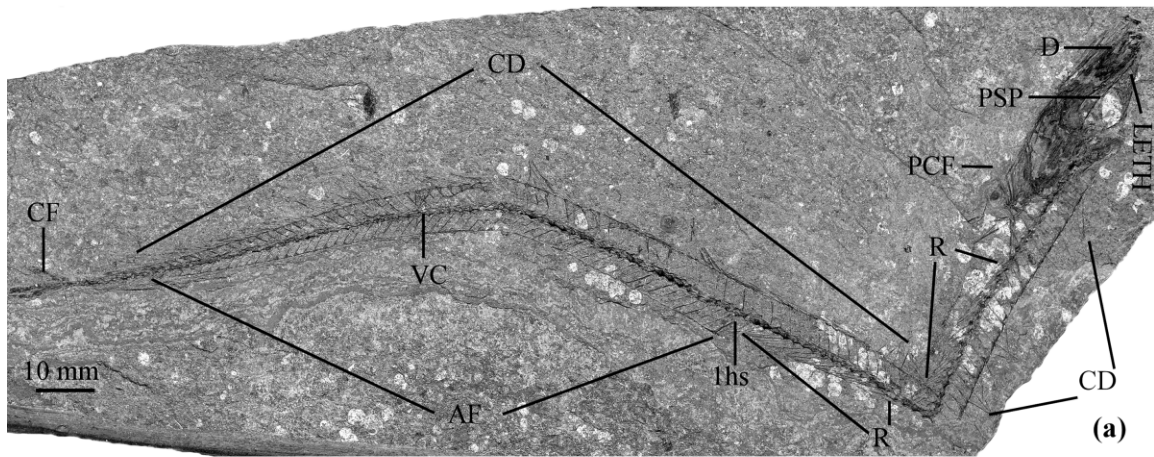

Figure 14 †*Anenichelum angustum*, River Belaya, N Caucasus, Russia; Rupelian: (a) holotype, PIN 1413/94; (b) PIN 1413/88. Both individuals pictured have been twisted during fossilisation. The anal fin in (a) is only visible through its pterygiophores; the rays are depressed against the body. Abbreviations: lhs=first haemal spine; D=dentary; dfs=dorsal-fin spine; F=fang; LETH=lateral ethmoid; PCF=pectoral fin; PCL=postcleithrum; POP=preoperculum; PSP=parasphenoid; R=ribs; VC=vertebral column.

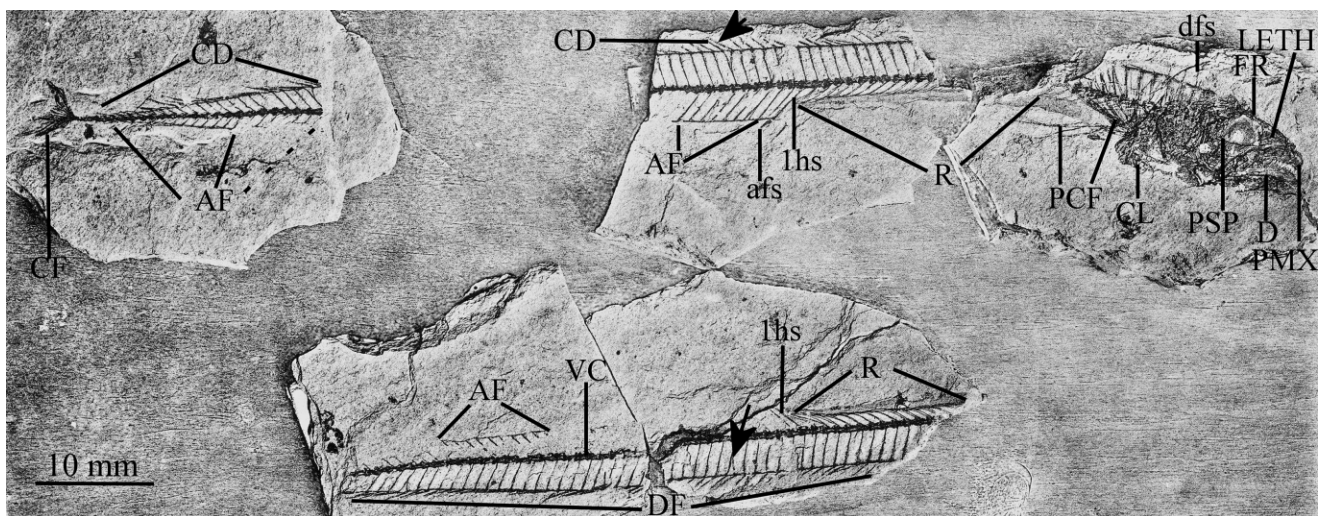

Figure 15 †*Anenichelum lednevi*, holotype, Suburb of Baku, Apsheron peninsula, Azerbaijan; Burdigalian. Image modified from Lednev (1914) with added lettering. The piece of matrix at the bottom is from the counterpart of the same individual and is pictured upside-down. Arrows indicate first 'irregular' dorsal-fin pterygiophore. Abbreviations: lhs=first haemal spine; AF=anal fin; afs=anal-fin spine; CD/DF=(continuous) dorsal fin; CF=caudal fin; CL=cleithrum; D=dentary; dfs=dorsal-fin spine; FR=frontal; LETH=lateral ethmoid; PCF=pectoral fin; PMX=premaxilla; PSP=parasphenoid; R=ribs; VC=vertebral column.

- 1995 †*Lepidopus lateralis* Dan. Bannikov & Parin, p. 184 (name only).
 1997 †*Lepidopus lateralis* Dan. Bannikov & Parin, p. 142 (name only).
 2010 †*Lepidopus lateralis* Dan. Bannikov, p. 134, pl. XXII, fig. 2.

Holotype. PIN 2181/65 (Fig. 16a).

Type locality. Sumgait River, Apsheron peninsula, Azerbaijan; lower–middle Miocene (Tarkhanian–Chokrakian, Langhian, *Spirialis* clays).

Diagnosis. About 114 (ca. 40+74) vertebrae. Dorsal fin with ca. 110 elements (distinction between spines and soft rays cannot be made). Anal fin with about 65 rays.

Other distinguishing characters. Second anal-fin spine well developed and spiniform (Fig. 16b).

Hypodigm. Thirteen specimens from the type locality, in PIN.

Description. Head length 2.1 times greater than body depth. More details in Danil'chenko (1980).

Remarks. †*L. lateralis* is morphologically close to the Recent *Lepidopus caudatus* (Euphrasen, 1788). They share similar apomorphic character states such as the amount of vertebrae and of elements of the unpaired fins. The only difference is that in *L. caudatus* the second anal-fin spine is reduced in size and plate-like or triangular.

The soft pelvic-fin rays are unknown. It is not known whether the specimens have lost, or have never possessed them. Normally, one or two soft pelvic fin rays are present in *Lepidopus* (Nakamura & Parin 1993; Gago 1998).

The precaudal skeleton of the upper Miocene (Chelif Basin, NE Algeria) †*Lepidopus proargenteus* Arambourg, 1927 is, as far as can be seen, identical to that of †*L. lateralis*. However, as in *L. caudatus*, the second anal-fin spine of †*L. proargenteus* is reduced, and that species also has a different geological and geographical provenance from †*L. lateralis*. Additional study of †*L. proargenteus* is necessary to reveal whether it does differ from *L. caudatus*.

Superfamily Scombroidea Rafinesque-Schmaltz, 1815

Remark. Superfamily Scombroidea as used in this paper is based on Carpenter *et al.* (1995). A phylogenetic outline of this taxon is given in Figure 2, in which can be seen that it is paraphyletic, because the complete group Xiphoidea is excluded (this may point to the necessity to exclude billfish from scombroids).

Family Scombridae Rafinesque-Schmaltz, 1815
 Subfamily Scombrinae Rafinesque-Schmaltz, 1815
 Tribe Scombrini Rafinesque-Schmaltz, 1815
 Genus *Auxides* Jordan, 1919

Type species. †*Thynnus propterygius* Agassiz, 1835, p. 292, by original designation.

Diagnosis. Small teeth, lachrymal slightly longer than orbit; 31 vertebrae; haemal spine 1 thickened and bent; two hypural plates (hypurals 1–2 on the one hand and 3–4 on the other hand fused together).

Other distinguishing characters. Dorsal fins drawn closely together; body covered by medium-sized scales; orbit partially covered by sclerotics.

Remarks. Species of †*Auxides* from the former USSR are generally known as †*Scombrosarda* Danil'tshenko, 1962 (Danil'chenko 1962, 1980; Bannikov 1985). The type species designated by Jordan (1919) for †*Auxides* was subsequently attributed to †*Scombrosarda* (Bannikov & Sorbini 1984;

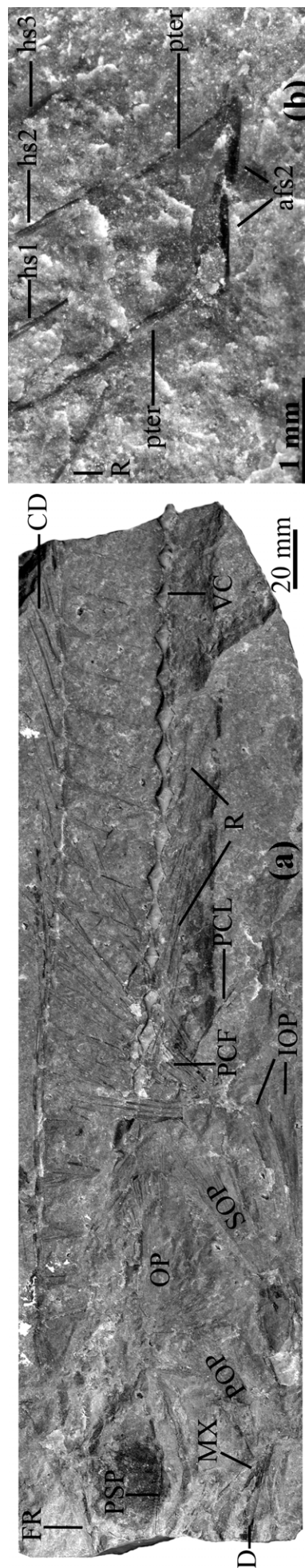

Figure 16 †*Lepidopus lateralis*, River Sumgait, Apsheron peninsula, Azerbaijan; Langhian, (a) holotype, PIN 2181/65; (b) detail of PIN 2181/96, showing second anal-fin spine, articulating with caudal end of first anal-fin pterygiophore. Spine seems to be broken in two. Apparent dagger-shaped outgrowth on spine is false impression in matrix. Abbreviations: afs = anal-fin spine; CD = continuous dorsal fin; D = dentary; FR = frontal; hs = haemal spine; IOP = interoperculum; MX = maxilla; OP = operculum; PCF = pectoral fin; PCL = postcleithrum; POP = preoperculum; PSP = parasphenoid; pter = pterygiophore; R = ribs; SOP = suboperculum; VC = vertebral column.

Bannikov 1985). †*Scombrostarda* was eventually synonymised with †*Auxides* by Monsch (2006). Three species of †*Auxides* are known from the former Soviet territories.

Bannikov (1985, p. 75; 2010) synonymises †*Tamesichthys* Casier, 1966 from the London Clay with †*Auxides*. However, the holotype of †*Tamesichthys* (BMNH 41319) is not identical to †*Auxides*; it lacks the characteristic curved crescent-shaped preoperculum and has a deeper head. Monsch (2005) recognises †*Tamesichthys* as a separate genus.

The phylogenetic position of †*Auxides* in relation to Recent Scombrini (mackerels, genera *Scomber* and *Rastrelliger* Jordan & Starks, 1908) is unresolved, even though it is thought that the fossil genus is the primitive sister group of Recent scombrins (Monsch 2006).

†*Auxides turkmenicus* (Danil'tshenko, 1968)
(Fig. 17)

- 1968 †*Scombrostarda turkmenica* Danil'chenko, p. 151, pl. 33, fig. 3, text-fig. 16.
1980 †*Scombrsarda turkmenica* Dan. Danil'chenko, p. 152.
1984 †*Scombrostarda turkmenica* Dan. Bannikov & Sorbini, p. 308, fig. 4.
1985 †*Scombrostarda turkmenica* Dan. Bannikov, p. 14, pl. 1, figs. 1–3, text-figs. 2–4a.
1993 †*Scombrostarda turkmenica* Dan. Patterson, p. 650 (name only).
1997 †*Scombrostarda turkmenica* Dan. Bannikov & Parin, p. 134 (name only).
2000b †*Scombrinus turkmenicus* (Dan.) Monsch, p. 112, fig. 7.23 (*pro parte*).
non2000b †*Scombrinus turkmenicus* (Dan.) Monsch, p. 112 (*pro parte*=*A. devius*).
2010 †*Auxides turkmenicus* (Dan.) Bannikov, p. 136, pl. XXII, fig. 3.

Holotype. PIN 2179/51 (part and counterpart, Fig. 17a–b).

Type locality. Uilya-Kushlyuk, Turkmenistan; upper Palaeocene (Thanetian, lower part of Danata Svita).

Diagnosis. First dorsal fin with an estimated 13 spines, second dorsal fin with one spine and 12–13 rays, anal fin with two rigid spines and 11–12 rays. Six anal and dorsal finlets.

Other distinguishing characters. Haemal spine 1 only weakly thickened and curved (Fig. 17c–d). First dorsal fin originates above fifth vertebra. Pelvic fin just caudal of pectoral fin (Fig. 17e).

Hypodigm. Thirty-eight specimens from the type locality, in PIN.

Description. The latest detailed description is Bannikov (1985). There, it is noted that first dorsal fin contains 13 rays. Only specimen from which amount of spines in that fin can be assessed with some confidence is the holotype. Although seemingly having 13 spines, only 10 are clearly preserved. To Bannikov's (1985) description it can be added furthermore that caudal fin contains 30 lepidotrichia, including 17 principal rays. Head length 27–30% of standard length.

Remarks. Monsch (2000b) identified specimen BMNH 1898 from the middle Eocene of Iran as †*A. turkmenicus*. The fossil is however more likely to be identified with †*Auxides devius* (see below).

†*Auxides devius* (Danil'tshenko, 1962)
(Figs 18–20)

- 1962 †*Scombrostarda devia* Danil'chenko, p. 122, fig. 10.
1980 †*Scombrostarda devia* Dan. Danil'chenko, p. 153.

- 1984 †*Scombrostarda devia* Dan. Bannikov & Sorbini, p. 316 (name only).
1985 †*Scombrostarda devia* Dan. Bannikov, p. 17, pl. 1, figs. 4, 5, text-fig. 5.
1997 †*Scombrostarda devia* Dan. Bannikov & Parin, p. 135 (name only).
2000b †*Scombrinus devius* (Dan.) Monsch, 2000b, p. 111, fig. 7.21.
non2000b †*Scombrinus turkmenicus* (Dan.) Monsch, p. 112 (*pro parte*).
2010 †*Auxides devius* (Dan.) Bannikov, p. 136, text-fig. 76.

Holotype. PIN 1413/79 (part and counterpart, Fig. 18).

Type locality. Tbilisi, Georgia; middle Eocene (Dabakhana Svita).

Diagnosis. Six dorsal and seven anal finlets. Haemal spine 1 strongly curved and thickened into sickle-like shape (Fig. 18c).

Other distinguishing characters. First dorsal fin originates above sixth or seventh vertebra. First dorsal fin with 11–12 spines, second dorsal with one spine and 11 rays, anal fin with two spine and 10 rays. Pelvic fin immediately below pectoral fin.

Hypodigm. Only the holotype can be confidently assigned to this species. One other specimen that may belong to this species (see remarks).

Description. Head length 29–31% of standard length. More details in Bannikov (1985).

Remarks. Monsch (2000b) identified a formerly undetermined scombrid fossil, BMNH P18978 (Figs 19, 20) from Iran as †*Scombrinus turkmenicus*. However, the specimen rather shares apomorphies with †*A. devius*. The fossil is from the locality of Tang-e Kūreh (Imam Hassan Limestone member, Gurpi Formation). The Gurpi Formation is located in S Iran. The Iranian specimen has six dorsal finlets and seven anal finlets can be confidently assumed, even though only five anal pterygiophores are preserved (Fig. 20a). However, the curvature of the first haemal spine seems to be less than in the holotype of †*A. devius* (Fig. 20b). This feature may have arisen from poor preservation, but the trait in question is an important specific character within this genus (Bannikov & Sorbini 1984; Bannikov 1985). Based on existing material, BMNH P18978 cannot be confidently assigned to †*A. devius*. Interpretation of geological data, however, seems to reject the identity of †*Auxides devius*. The Gurpi Formation has a Maastrichtian age (Mohseni *et al.* 2011). †*A. devius* is from the middle Eocene. Moreover, the oldest †*Auxides*, †*A. turkmenicus*, is from the Thanetian, and scombroid radiation itself starts during the Danian (Patterson 1993). It is possible that the data on the collection label (on which the locality is misspelled as 'Tangi-Kora') are wrong, and that BMNH P18978 comes from the overlaying Pabdeh Formation. Pabdeh sediments date from Thanetian to Chattian. It is however also possible that the radiation of both scombroids and *Auxides* started earlier than previously thought. Additional studies on Iranian material and geology must resolve this.

†*Auxides cernegurae* (Ciobanu, 1970)
(Fig. 21)

- 1970 †*Pinulothunnus cernegurae* Ciobanu, p. 83, pl. 5, fig. 1.
1977 †*Pinulothunnus cernegurae* Ciob. Ciobanu, p. 125, pl. 46, fig. 1.
1980 †*Scombrostarda limata* Danil'chenko, p. 154, pl. 18, fig. 1, text-fig. 49.
1984 †*Scombrostarda cernegurae* (Ciob.) Bannikov & Sorbini, p. 309, fig. 5.

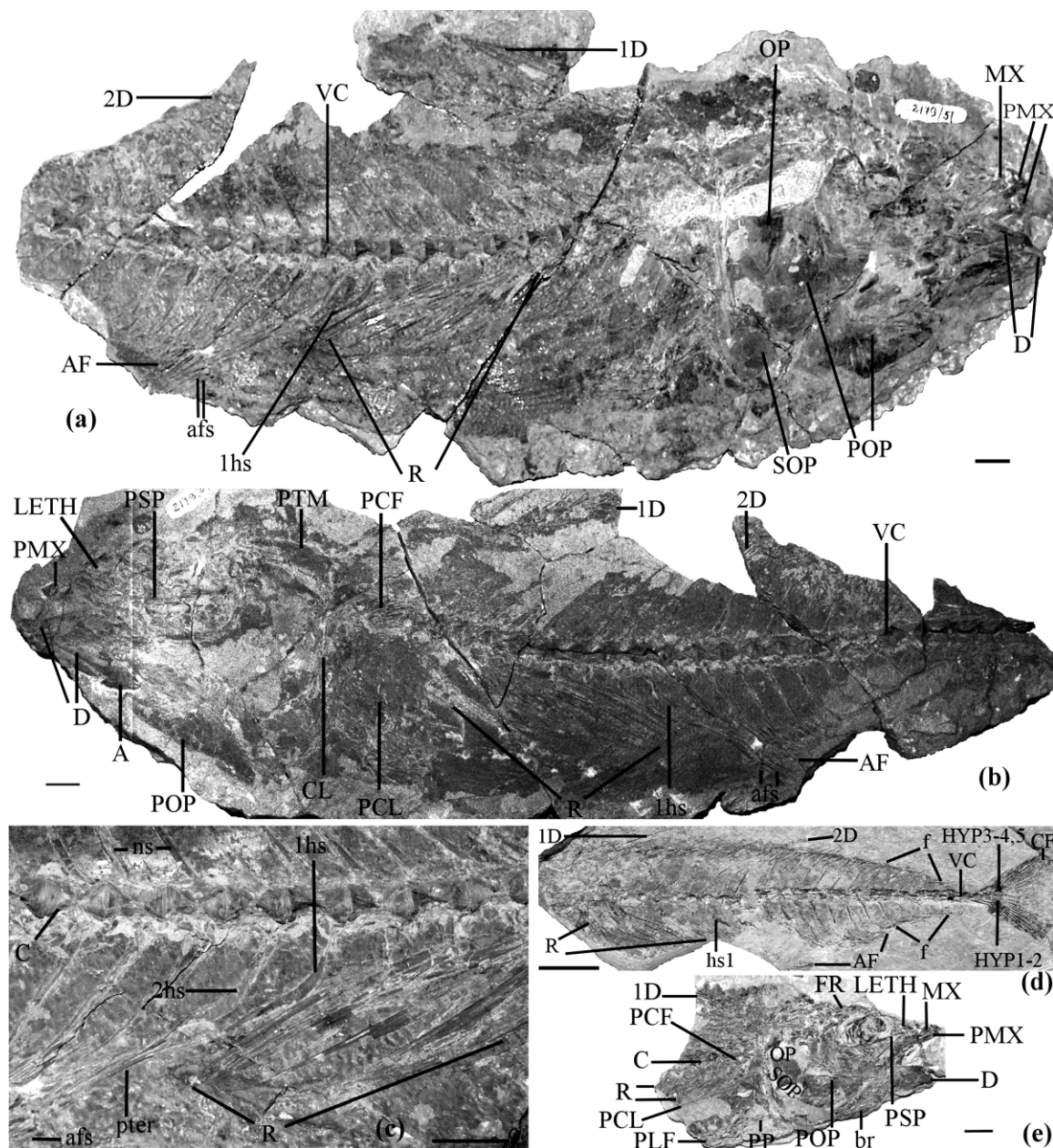

Figure 17 †*Auxides turkmenicus*, Uilya-Kushlyuk, Turkmenistan; Thanetian: holotype (a–c), PIN 2179/51 (part and counterpart); (d) PIN 2179/53; (e) PIN 1762/89. Scale bars=10 mm. Abbreviations: 1D=first dorsal fin; 2D=second dorsal fin; 1hs=first haemal spine; 2hs=second haemal spine; A=angular; AF=anal fin; afs=anal-fin spine; br=branchiostegal rays; C=centrum; CF=caudal fin; CL=cleithrum; D=dentary; f=finlets; HYP=hypural; LETH=lateral ethmoid; MX=maxilla; ns, neural spine; OP=operculum; PCF=pectoral fin; PCL=postcleithrum; PLF=pelvic fin; PMX=premaxilla; POP=preoperculum; PP=pelvic plate; PSP=parasphenoid; pter=pterygiophore; PTM=posttemporal; R=ribs; SOP=suboperculum; VC=vertebral column.

1985 †*Scombrsarda cernegurae* (Ciob.) Bannikov, p. 19, pl. 2, fig. 1, text-figs. 6–9.

1997 †*Scombrsarda cernegurae* (Ciob.) Bannikov & Parin, p. 138 (name only).

2000b †*Scombrinus cernegurae* (Ciob.) Monsch, p. 110, fig. 7.20.

2010 †*Auxides cernegurae* (Ciob.) Bannikov, p. 136, pl. XXII, fig. 4.

Holotype. MSNPN 158.

Type locality. Cernegura, near Piatra Neamț, Romania; lower Oligocene (Rupelian, bituminous marls).

Diagnosis. Dorsal fins somewhat separated by distance of more than half of orbit diameter. Haemal spine 1 expanded and strongly bent into a sickle shape (some variety in this trait, but in most specimens curvature strong and sickle-like shape

clear), with caudal hook. First dorsal fin with 10–11 spines. Pelvic fin caudal of pectoral fin.

Other distinguishing characters. Second dorsal fin with one spine and 11 rays. Five anal and dorsal finlets.

Hypodigm. The collection of MSNPN contains two specimens from the lower Oligocene of Piatra Neamț (Cernegura, Pietricica). The collection in PIN contains 98 specimens from a location 1 km from the village Abadzekhskaya at the Belaya River; two from N Osetiya; one from the Pshekha River; one from the river Malyi Zelenchuk, N Caucasus, Russia; three from the right bank of the Gumista River in Abkhazia (all: Pshekha Horizon, lower Oligocene: Rupelian); and one from Delyatin, western Ukraine (Rupelian, lower Menilite Svita).

Description. The last detailed description was provided by Bannikov (1985). To this description it can be added that the hypurostegic caudal fin contains 30–40 rays, including 17

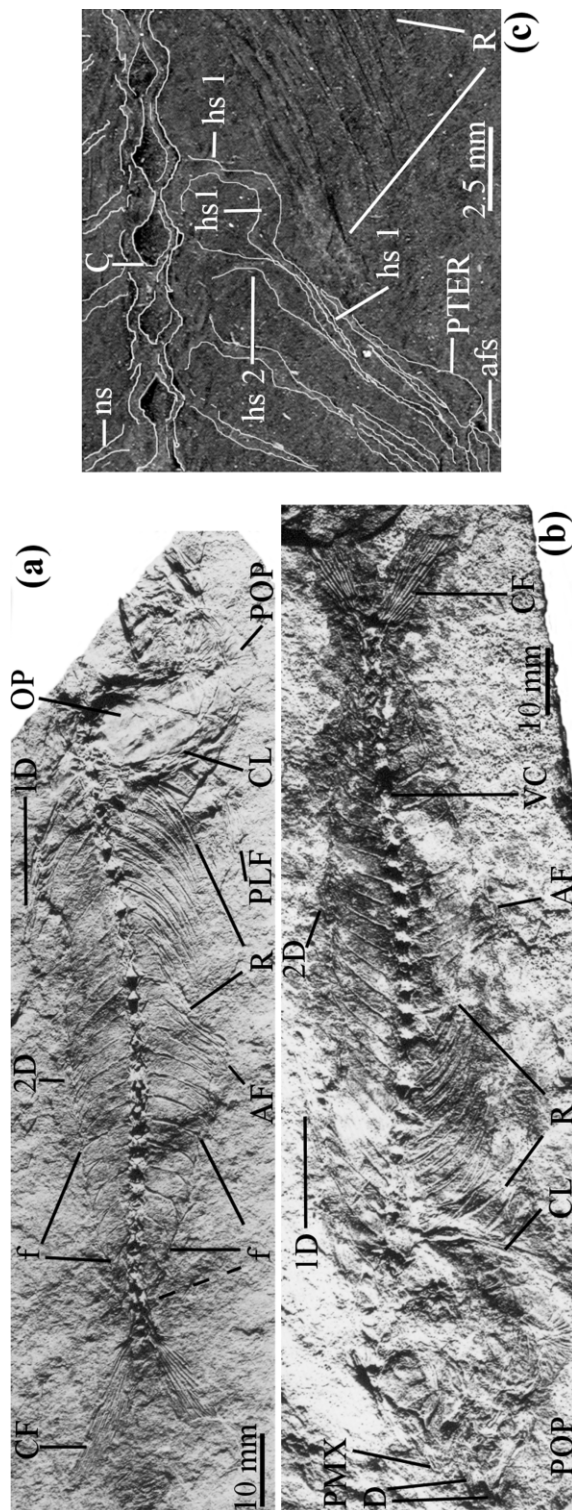

Figure 18 †*Auxides devius*, holotype, PIN 1413/79; (a) overview of part; and (b) counterpart; (c) detail of (a) with clarifying tracing marks on vertebral column and anal fin; Tbilisi, Georgia; Lutetian. Abbreviations: 1D=first dorsal fin; 2D=second dorsal fin; AF=anal fin; afs=anal-fin spine; C=centrum; CF=caudal fin; CL=cleithrum; D=dentary; f=finlets; hs=haemal spine; ns=neural spine; OP=operculum; PLF=preoperculum; POP=premaxilla; PTER=pterygiophore; R=ribs; VC=vertebral column.

principal lepidotrichia. Head length is 31–33% standard length. Scale covering slightly stronger around pectoral girdle, giving false impression of *Thunnus*-like corselet (Fig. 21a). Two transfer-prepared specimens, PIN 3363/138 (Fig. 21b–c) and PIN 3363/139 (Fig. 21d–e) reveal many details of the cranial region.

Genus *Scomber* Linnaeus, 1758

Type species. *Scomber scombrus* Linnaeus, 1758, p. 297, by subsequent designation.

Diagnosis. Vomer and palatine toothed; lachrymal larger than diameter of orbit; thirty-one vertebrae; hypurals 1–2 and 3–4 respectively fused together; caudal fin hypurostegic; 5–6 pairs of finlets.

Other distinguishing characters. Thickened and curved haemal spine 1 not modified as strongly as in †*Auxides* and without caudal hook as in †*A. cernegurae*.

Remarks. Fossil forms are known from the Cenozoic of Europe, N America and Iran (see David 1943; Arambourg 1967). The three known species from former Soviet territories are described below. Bannikov (1985) included †*Auxides* and †*Thyrision* Jordan & Gilbert, 1920 in his synonymy of *Scomber*. †*Auxides* was understood to be identical to *Scomber* based on David (1943). †*Thyrision* is, according to the Principle of the First Reviser (ICZN 1999, art. 24), a junior synonym of †*Thyrsocles* Jordan in Jordan & Gilbert, 1920. The revision was carried out by Jordan (1921). The type specimen of †*Thyrsocles kriegeri* (Jordan & Gilbert, 1919), possessing almost 50 vertebrae and lacking hypurostegy, is not morphologically close to *Scomber* (see Jordan & Gilbert 1919; David 1943). Specimens of †*T. kriegeri* studied by one of us (KAM) confirm the differences between †*Thyrsocles* and *Scomber*. USNM 10283, 11059 and USNM 10963 possess between more than 43 and more than 48 vertebrae. The entry of †*Thyrision* in the synonymy of a fossil species of ‘*Pneumatophorus*’ Jordan & Gilbert, 1883 (= *Scomber*) in David (1943) concerns a generic misidentification of a specimen that was previously made by Jordan (1925).

With the naked eye, five pairs of finlets can be seen in living *Scomber*. However, the fifth and sixth finlets are strongly bound together by a membrane. Each of these finlets is supported by a different pterygiophore (Nauen & Lauder 2000). A good overview of the taxonomic characters of *Scomber*, which assisted in recognising apomorphies and pleiomorphies in this genus, is Matsui (1967).

†*Scomber voiteştii* Paucă, 1929b

(Fig. 22)

- 1929a †*Scomber oligocenicus* Paucă, p. 117.
- 1929b †*Scomber voiteştii* Paucă, p. 121, fig. 1.
- 1929c †*Scomber voiteştii* Paucă. Paucă, p. 211 (established as valid name, following ICZN, 1999, art. 24).
- 1933 †*Scomber voiteştii* Paucă. Weiler, p. 15, pl. 2, fig. 6, text-figs 4, 5.
- 1934 †*Scomber voiteştii* Paucă. Paucă, p. 613, pl. 3, fig. 7, text-fig. 14.
- 1942 †*Scomber voiteştii* Paucă. Böhm, p. 21, pl. 2, fig. 2.
- 1958 †*Scomber voiteştii* Paucă. Jonet, p. 53, pl. 6, fig. 5.
- 1960 †*Scomber voiteştii* Paucă. Danil’chenko, p. 152 (*non* pl. 22, fig. 1).
- 1968 †*Scomber voiteştii* Paucă. Jerzmańska, p. 466.
- 1980 †*Scomber voiteştii* Paucă. Danil’chenko, p. 160.
- 1985 †*Scomber voiteştii* Paucă. Bannikov, p. 25, pl. 2, figs 2, 3, text-fig. 10.
- 2000b †*Scomber voiteştii* Paucă. Monsch, p. 107.

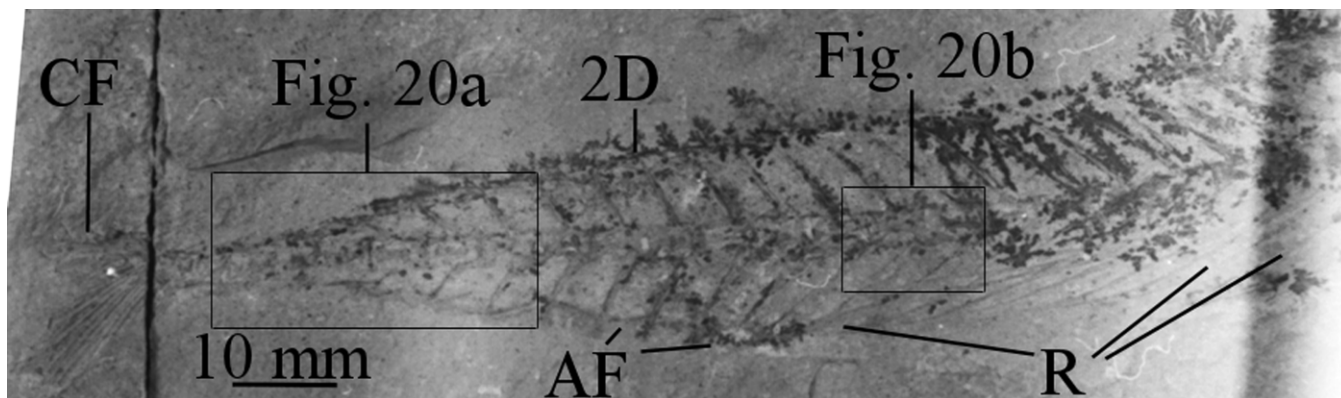

Figure 19 *cf.* †*Auxides devius*, BMNH P18978, Tang-e-Kūreh, Iran; Maastrichtian? The specimen is of poor quality and the camera used for the photograph turned out to be damaged. Sketches of boxed areas shown in Figure 20. Abbreviations: 2D=second dorsal fin; AF=anal fin; CF=caudal fin; R=ribs.

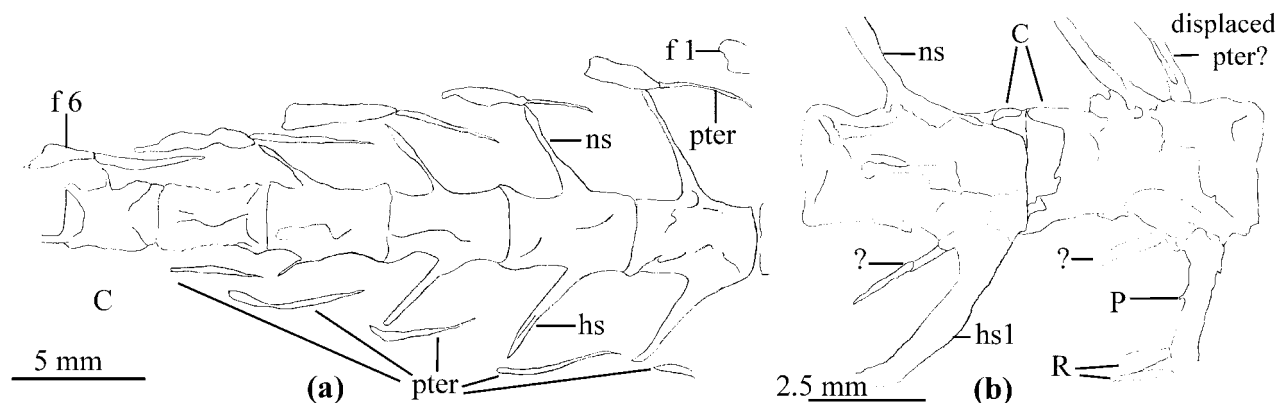

Figure 20 Sketches of fragments of *cf.* †*Auxides devius*, BMNH P18978, Tang-e Kūreh, Iran; Maastrichtian? (a) the preserved remains of dorsal and anal finlets; (b) detail of first caudal vertebra and the one preceding it. Abbreviations: C=centrum; f=finlet; hs=haemal spine; ns=neural spine; P=parapophysis; pter=pterygiophore; R=rib.

2010 †*Scomber voitestii* Paucă. Bannikov, p. 137, pl. XXIII, fig. 3.

Lectotype. Figure of specimen in Paucă (1929b, Fig. 1); location of specimen unknown.

Type locality. Moțăeni-Dâmbovița, Romania; Oligocene (it is unfortunately not possible to give a stage-level stratigraphic attribution), Pucioasa-Schichten.

Diagnosis. First and second dorsal fin separated by distance slightly longer than base of first dorsal. Fourteen precaudal vertebrae. Haemal spine 1 comparatively strongly thickened and curved (but not posteriorly hooked, see Weiler 1933, Text-fig. 4). Anal fin with 11–13 rays.

Other distinguishing characters. First dorsal fin with 12 pterygiophores, first eight of which bearing spines. Second dorsal fin with one spine and 10–11 rays. Anal fin with two small spines (Recent forms of this genus have only one).

Hypodigm. The collections of PIN contain three specimens from Pasechnaya, Cis-Carpathians, Ukraine: Oligocene (Menilite Svita); and one from Pietricica (near Piatra Neamț), Romania, upper Oligocene (Chattian, upper Dysodilic Shales). There is one specimen in ZPalWr and an unknown number of specimens in local institutions from the known distribution area. The species is known from the Carpathians and Hungary (Jerzmańska 1968). Its presence in the Caucasus (Danil'chenko 1960) is not confirmed (Bannikov 1985).

Description. Recent, well-accessible descriptions were given by Jerzmańska (1968) and Danil'chenko (1967).

†*Scomber cubanicus* Danil'tshenko, 1960 (Fig. 23a–b)

1960 †*Scomber cubanicus* Danil'chenko, p. 154, pl. 16, figs. 1, 2, text-fig. 31.

1964 †*Scomber cubanicus* Dan. Danil'chenko, pl. 11, fig. 6.

1980 †*Scomber cubanicus* Dan. Danil'chenko, p. 161.

1985 †*Scomber cubanicus* Dan. Bannikov, p. 27, pl. 2, figs. 4, 5, text-fig. 11.

1997 †*Scomber cubanicus* Dan. Bannikov & Parin, p. 139 (name only).

2000b †*Scomber cubanicus* Dan. Monsch, p. 106, fig. 7.18.

2010 †*Scomber cubanicus* Dan. Bannikov, p. 138, pl. XXIII, fig. 1.

Holotype. PIN 484/11 (two counterparts, Fig. 23b).

Type locality. Khadyzhensk town, Krasnodar Region, N Caucasus, Russia; upper Oligocene (Chattian, Kalmyk or Karadzhalga Horizon: Popov *et al.* 1993a, b).

Diagnosis. Space between dorsal fins slightly longer than base of first dorsal fin. This fin has 16–17 pterygiophores, last seven of which not bearing spines. Haemal spine 2 thicker than first and almost sickle-shaped.

Other distinguishing characters. Fifteen precaudal vertebrae. First dorsal fin with 9–10 spines. Second dorsal fin with one spine and 9–10 rays. Anal fin with two small spines and 10–11 rays. Haemal spine 1 only slightly thickened and curved.

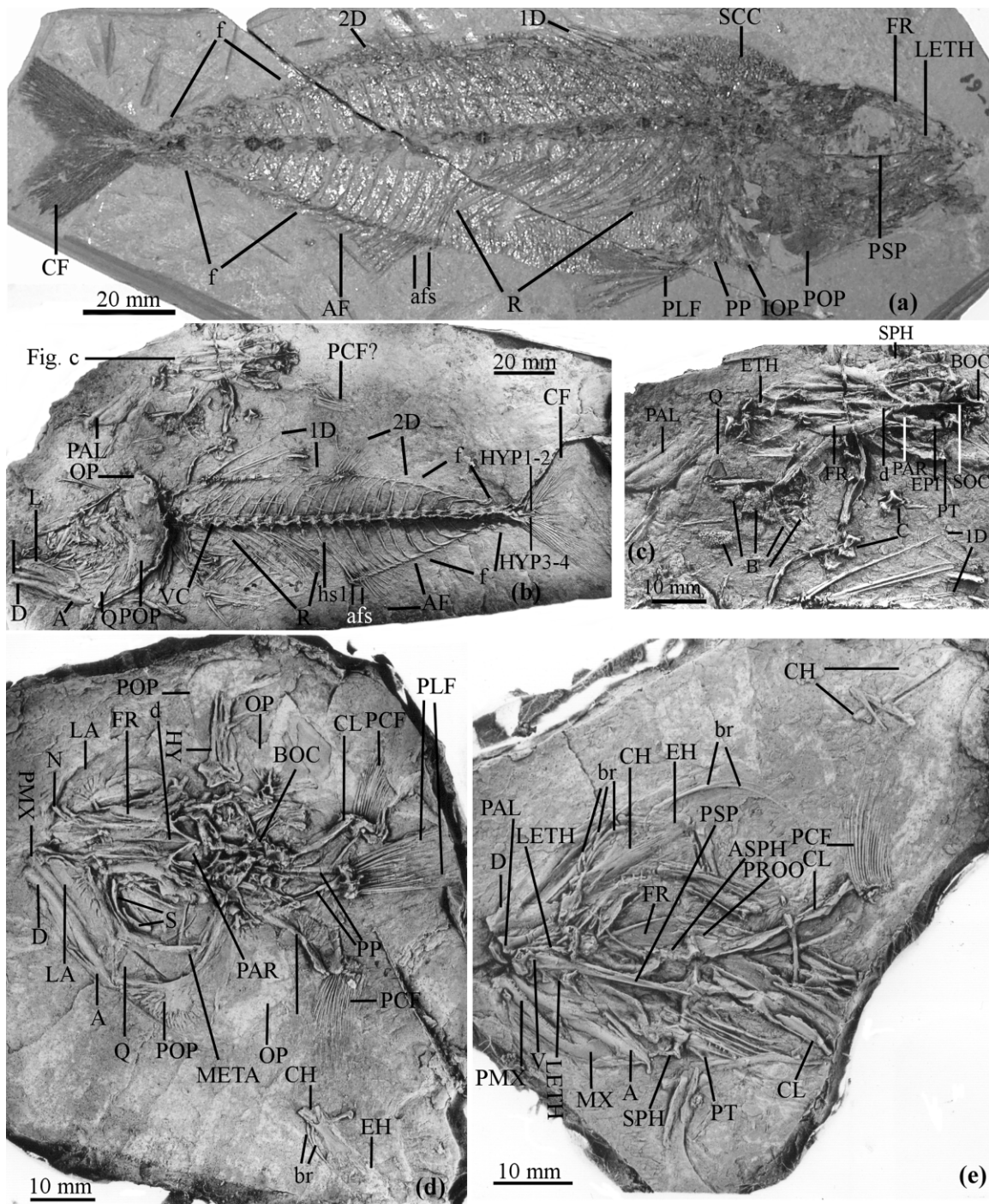

Figure 21 †*Auxides cernegurae*, River Belaya, N Caucasus, Russia; Rupelian: (a) PIN 3363/61, complete specimen with visible pseudo-corselet; (b) and (c) PIN 3363/138 (transfer-prepared), with detail of skull roof in (c); (d) and (e) PIN 3363/139 (transfer-prepared): (d) shows the dorsal view of a flattened skull, and (e) the ventral view. Abbreviations: 1D=first dorsal fin; 2D=second dorsal fin; A=angular; AF=anal fin; afs=anal-fin spine; ASPH=alisphenoid; BOC=basioccipital; br=branchiostegal rays; C=centrum; CF=caudal fin; CH=ceratohyal; CL=cleithrum; D=dentary; d=depression in surface; EH=ethmoid; EPI=epiotic; ETH=ethmoid; f=finlets; FR=frontal; hsl=haemal spine I; HY=hyomandibular; HYP=hypural; IOP=interoperculum; L/LA=lachrymal; LETH=lateral ethmoid; META=metapterygoid; MX=maxillae; N=nasal; OP=operculum; PAL=palatine; PAR=parietal; PCF=pectoral fin; PLF=pelvic fin; PMX=premaxilla; POP=preoperculum; PP=pelvic plate; PROO=prootic; PSP=parasphenoid; PT=pteryotic; Q=quadrate; R=ribs; S=sclerotic; SCC=scale covering; SOC=supraoccipital crest; SPH=sphenotic; VC=vertebral column.

Hypodigm. Besides the holotype, nine specimens from Islamdagh mount at the Sumgait River, Azerbaijan; two specimens from the river Dyubek-Chai, Daghestan, Russia. All specimens are from the same stratigraphic provenance as the holotype and are stored in PIN.

Description. Head length 27–28% of standard length. More details in Danil'chenko (1967) and Bannikov (1985). Some meristic counts are corrected in the diagnosis and other

distinguishing characters above. Furthermore we observed that pectoral fin contains 15–17 lepidotrichia.

†*Scomber gnarus* Bannikov, 1979a
(Fig. 24a–c)

1933 *Nemopteryx* (?) sp. Bogachev, p. 28, pl. 3, fig. 1.
non1936 *Scomber colias* Gmelin. Smirnov, p. 64, pl. 7, fig. 34.

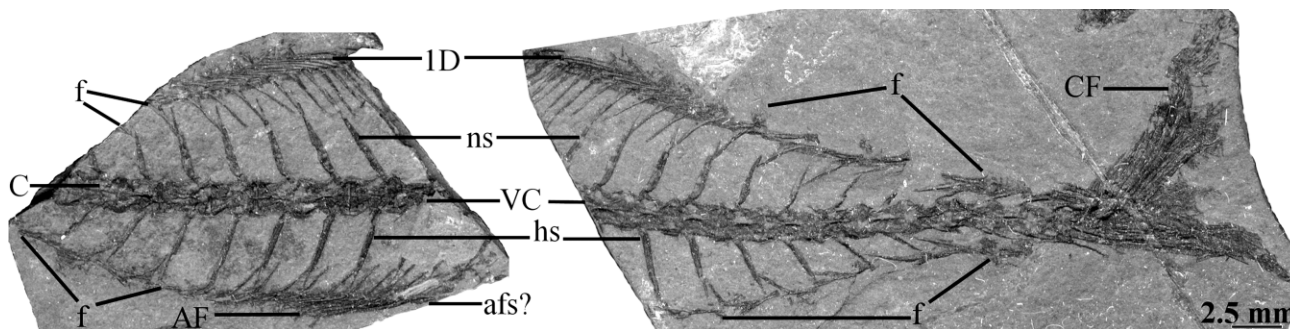

Figure 22 †*Scomber voiteștii*, PIN 491/10, Pasechnaya, Predcarpathians, Ukraine; Rupelian. Part and counterpart. Abbreviations: 1D=first dorsal fin; AF=anal fin; afs=anal-fin spine; C=centrum; CF=caudal fin; f=finlets; hs=haemal spine; ns=neural spine; VC=vertebral column.

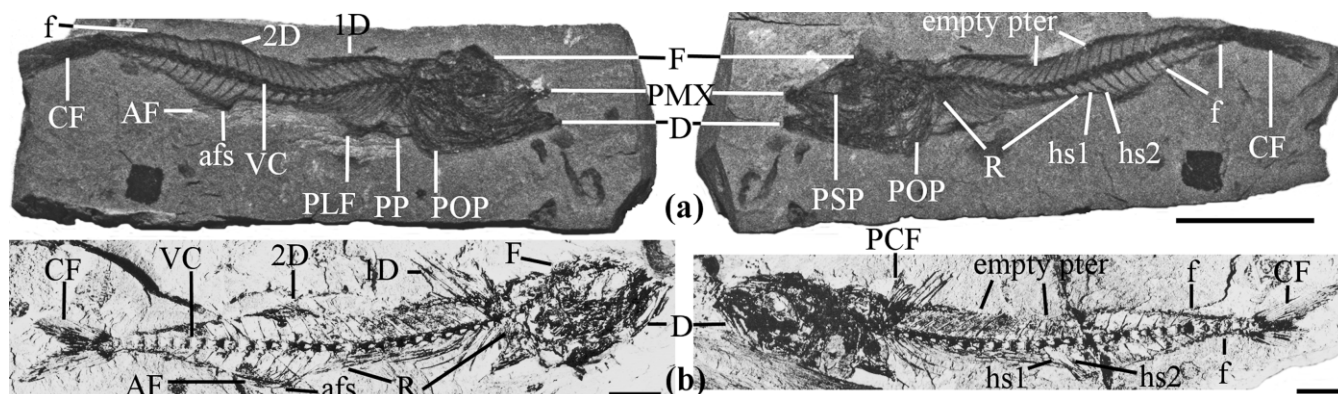

Figure 23 †*Scomber cubanicus*: (a) PIN 2180/11 (part and counterpart), Pirekishkyul' village, Azerbaijan; Chattian; (b) holotype (part and counterpart), PIN 484/11, Khadyzhensk town, Krasnodar Region, Russia; Chattian. Scale bars=10 mm. Abbreviations: 1D=first dorsal fin; 2D=second dorsal fin; AF=anal fin; afs=anal-fin spine; CF=caudal fin; D=dentary; F=frontal; f=finlets; hs=haemal spine; PCF=pectoral fin; PLF=pelvic fin; PMX=premaxillae; POP=preoperculum; PP=pelvic plate; PSP=parasphenoid; pter=pterygiophores; R=ribs; VC=vertebral column.

non1960 *Scomber japonicus* Houttuyn. Danil'chenko, p. 157, pl. 12, fig. 2.

1979a †*Scomber gnarus* Bannikov, p. 100, fig. 2.

1980 †*Scomber gnarus* Ban. Danil'chenko, p. 161.

1985 †*Scomber gnarus* Ban. Bannikov, p. 29, pl. 2, fig. 6, pl. 3, figs 1–3, text-figs 12–14.

1997 †*Scomber gnarus* Ban. Bannikov & Parin, p. 140 (name only).

2000b †*Scomber gnarus* Ban. Monsch, p. 106, fig. 7.19.

2010 †*Scomber gnarus* Ban. Bannikov, p. 138, pl. XXIII, fig. 2.

Holotype. PIN 3363/27 (Fig. 24a).

Type locality. Shirvanskaya village, near river Pshekha, N Caucasus, Russia; lower Miocene, upper Maykopian (lower Burdigalian, Sakaraul Horizon, see Popov *et al.* 1993b).

Diagnosis. First dorsal fin with 11–12 spines followed by 8–10 empty pterygiophores. Fifteen precaudal vertebrae.

Other distinguishing characters. Dorsal fins closer together than for any other member of this genus (this may be a reversal): space between dorsal fins slightly less than length of first dorsal. Second dorsal with one spine and 10–11 rays. Anal fin with two spines and 10–11 rays. In many specimens first, smaller spine missing, maybe as variable trait: one or two anal-fin spines. More likely, first spine missing as artefact of fossilisation. In specimens with two spines, first spine somewhat dissociated from rest of fin-(presumably an apomorphy). Two anal-fin spines are a plesiomorphy.

Hypodigm. Thirty-eight specimens from the type locality, ten from the banks of the river Chyornaya near Vladikavkaz, N Osetiya, Russia; nine specimens from Islamdagh mount near the Sumgait, Azerbaijan; 11 from the Kerch peninsula, Crimea

(Ukraine), two from the banks of the river Ullu-Chai, Dagestan, Russia. All specimens are in PIN and are of the same stratigraphic provenance as the holotype.

Description. To Bannikov's (1985) detailed description can be added that caudal fin contains 22–28 lepidotrichia, including 17 principal rays. Head length 30–32% of standard length.

†*Scomber* aff. *caucasicus* Bogachev, 1933
(Fig. 25)

1933 †*Auxis caucasica* Bogachev, p. 26, pl. 11, fig. 2.

2006 †*Scomber* aff. *caucasicus* Bog. Carnevale *et al.* p. 692.

2009 †*Scomber* aff. *S. caucasica* Bog. Bannikov, p. 569 (name only).

2010 †“*Scomber caucasica*” Bog. Bannikov, p. 139 (name only).

Holotype. Whereabouts of holotype of †*Auxis caucasica* are unknown, but figure of specimen exists (Bogachev 1933, pl. 11, fig. 2).

Type locality. The type locality of †*A. caucasica* is near Grozny in Chechnya, Russia; middle Miocene (Sarmatian *s.l.*).

Diagnosis. Synapomorphies of *Scomber*: small teeth on premaxilla, operculum with concave indentation in hind margin.

Other distinguishing characters. First dorsal fin with 8–9 spines, first two haemal spines expanded medially and clearly curved as a sickle (apomorphy).

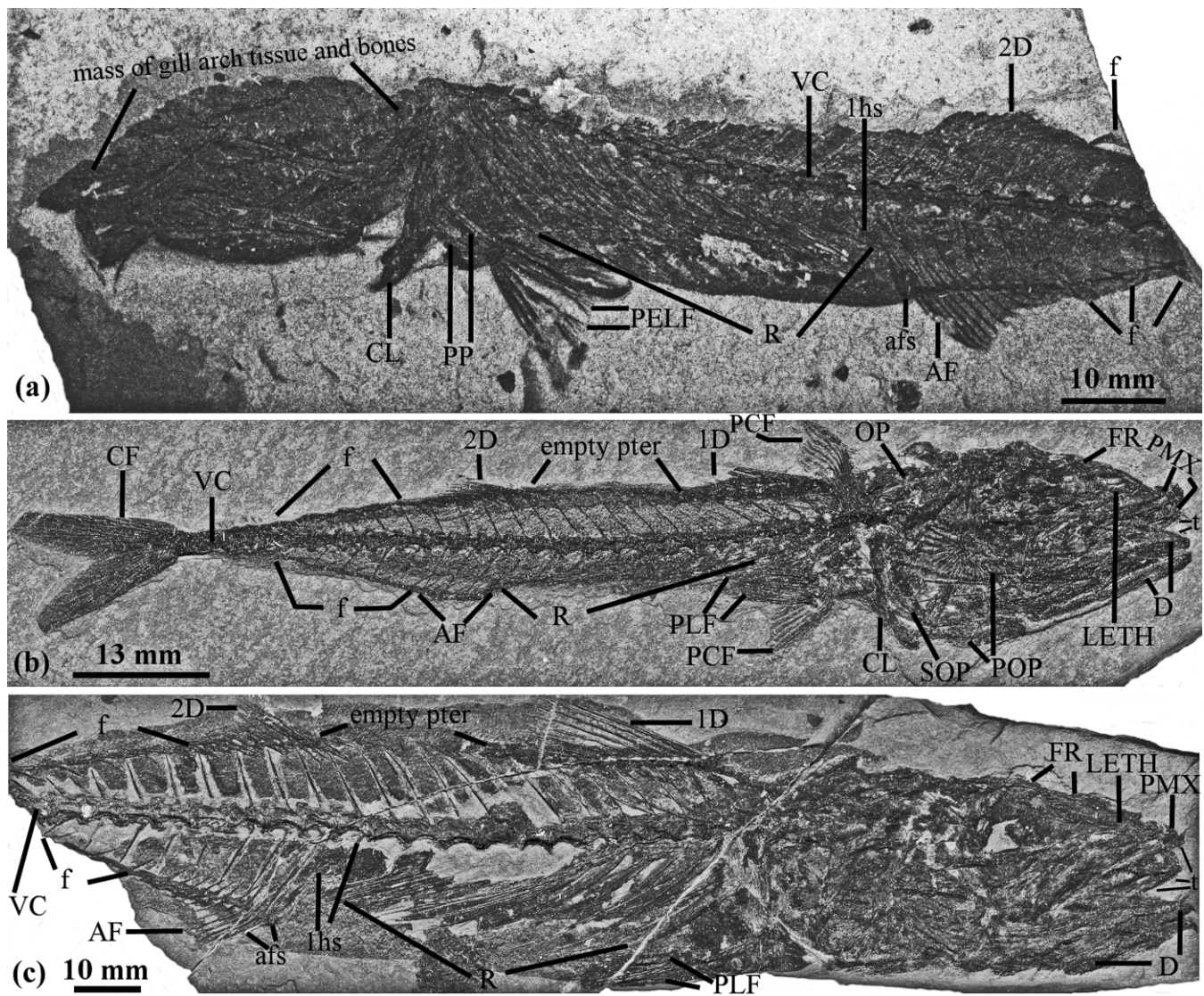

Figure 24 †*Scomber gnarus*, River Pshekha, near Shirvanskaya village, N Caucasus, Russia; Burdigalian: (a) holotypic counterpart, PIN 3363/2; (b) PIN 3363/43; (c) PIN 3363/47. Abbreviations: 1D=first dorsal fin; 2D=second dorsal fin; lhs=first haemal spine; AF=anal fin; afs=anal-fin spine; CF=caudal fin; CL=cleithrum; D=dentary; f=finlets; FR=frontal; LETH=lateral ethmoid; OP=operculum; PCF=pectoral fin; PELF/PLF=pelvic fin; PMX=premaxilla; POP=preoperculum; PP=pelvic plate; pter=pterygiophores; R=ribs; SOP=suboperculum; t=teeth; VC=vertebral column.

Hypodigm. Carnevale *et al.* (2006) tentatively assign PIN 5073/119 as †*Scomber caucasicus*. The specimen was collected near Tsurevsky village, left bank of the river Pshekha, lower Sarmatian (Vолhnyian, Tsurevsky Formation).

Description. See Carnevale *et al.* (2006).

Remarks. Bannikov (1985) argued that the specimen that Bogachev (1933) named †*Auxis caucasica* belongs to the genus *Scomber*, although he did not inaugurate the combination †*Scomber caucasicus*. PIN 5073/119 is similar to †*S. caucasicus*, but is less complete than Bogachev's holotype, hence its identity is uncertain. It is not clear if the characteristic structure of the first two haemal spines of PIN 5073/119 also appears in the holotype of †*S. caucasicus*. Carnevale *et al.* (2006) tentatively assign the fossil to †*S. caucasicus*, because its age and proximity to the type locality of that species match.

Tribe †Eocoelopomini trib. nov.

Diagnosis. Frontal with postero-superior fossae extending to near middle of orbit. Frontals anterior of these fossae thickened and ornamented with more or less coarse grooves (Figs 26–27). About 40 vertebrae.

Type genus. †*Eocoelopoma* Woodward, 1901.

Remarks. This tribe includes three genera: †*Eocoelopoma*, †*Microrhynchus* Monsch, 2005 (which at its first published description is 'classified' under Scombroidei *incertae familiae*) and †*Palaeothunnus* Bannikov, 1978. Bannikov (1978, 1985, 2010) diagnosed †*Palaeothunnus* as a member of the Thunninae (i.e. Sardini+Thunnini *sensu* Carpenter *et al.* 1995) because it has a deep, fusiform body, a blunt angle between the vertebral column and neural or haemal spines, small teeth and a moderately high number of vertebrae (41 in †*Palaeothunnus*, 37–55 in Sardini and Thunnini). Bannikov (1985) hypothesised that Recent Thunnini stem from †*Palaeothunnus*. However, this fossil genus is in many regards more primitive than both bonitos and tunnies. The hypurals of †*Palaeothunnus* are fused in a similar way as in *Scomber*. †*Palaeothunnus*' scales are larger than in *Scomber* and the scales seem slightly enlarged in the pectoral region, which resembles the squamation of †*Auxis*. In its number of vertebrae and finlets, however, †*Palaeothunnus* shows derived states for these characters relative to *Scomber*. †*Palaeothunnus* has more vertebrae than Recent Scombrini and could fit in that regard also within the tribe Scomberomorini. Within that taxon, however, the fusion

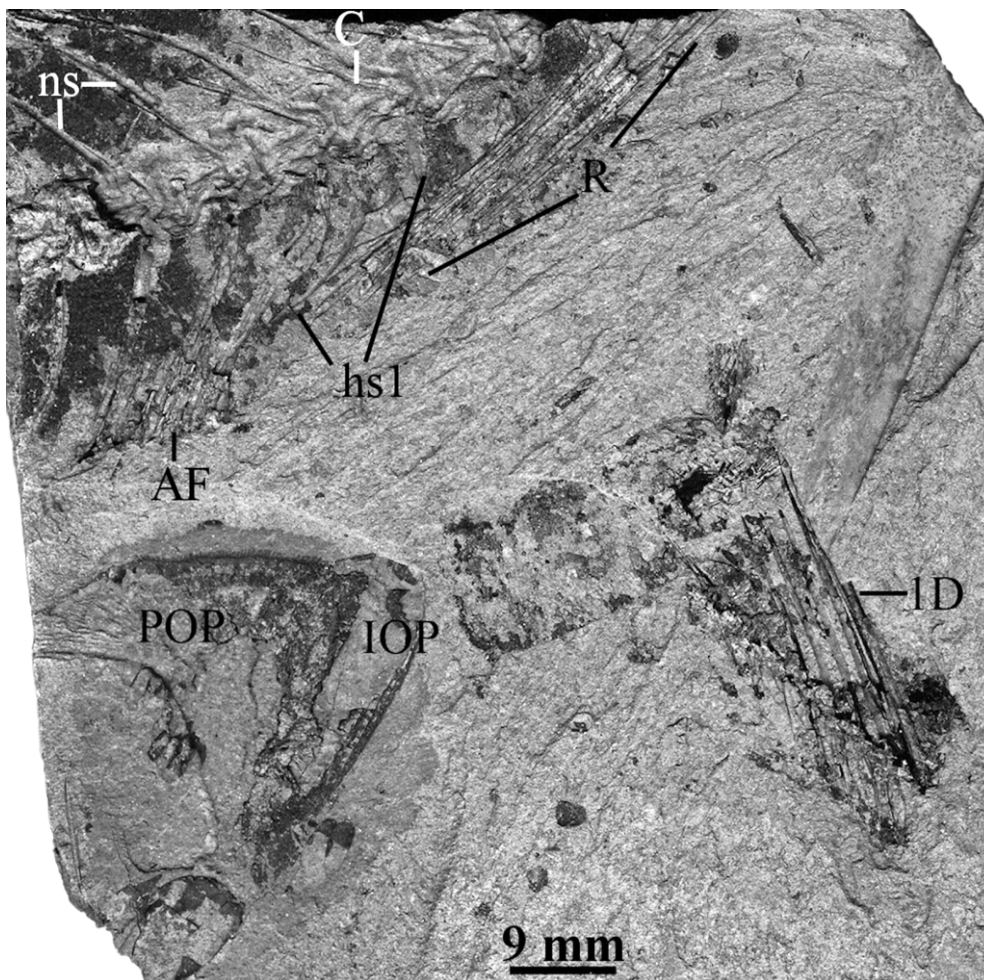

Figure 25 †*Scomber* aff. *caucasicus*, fragment, PIN 5073/119; River Pshékha, near Tsurevsky village, N Caucasus, Russia; Serravalian. The curved second haemal spine is hard to see on this photograph. Abbreviations: ID=first dorsal fin; AF=anal fin; C=centrum; hs1=first haemal spine; IOP=interoperculum; ns=neural spine; POP, preoperculum; R=ribs.

between hypurals is stronger than in this fossil. †*Eocoelopoma* has previously been classified as a member of the ‘Scomberomorinae’ (Bannikov 1985, 2010). However, we now recognise remarkable synapomorphies of †*Eocoelopoma* and †*Palaeothunnus* in the skull roof (see above). These traits are evidence of their common ancestry, despite noticeable differences between the two genera (see below). However, both genera seem to possess a combination of characters that would place them between more primitive scombrids and the Sardini+Thunnini clade. In †*Eocoelopoma*, preural vertebrae 2–4 are abruptly (but not as abruptly as in Thunnini) shortened, there are remains of a bony caudal keel and the hypural plate has no caudal notch. The remaining member of this tribe, †*Microrhynchus*, was described in Monsch (2005). The new tribe is tentatively placed as the primitive sister group of the Sardini+Thunnini clade.

Genus †*Eocoelopoma* Woodward, 1901

Type species. †*Eocoelopoma colei* Woodward, 1901, p. 470, by original designation.

Diagnosis. Anterior margin of vomer spatulate-shaped (see picture of *Eocoelopoma gigas* Casier, 1966; Monsch 2005, fig. 28) rather than concave, comparable to *Scomberomorus* (see Collette & Russo 1985). First six caudal vertebrae with small mid-lateral fossa. Nine to ten dorsal, and 7–8 anal finlets. Hypural plate consisting of hypurals 1–4 (–5) and uroneural, without caudal notch. Preural vertebrae 2–4 remarkably, but

not very abruptly, shortened compared to preceding ones. Traces of weak bony caudal keel on sixth preural vertebra.

Other distinguishing characters. Vertebrae about 40 (18?–20?+20). Pterygiophore of first dorsal fin inserted into fourth interneural space. Teeth relatively large. Second dorsal fin with 12–13 rays (presence or absence of spines uncertain). Anal fin with two spines and 9–10 rays.

Remarks. The most posterior vertebrae have thin lateral carinae that appear somewhat damaged (Fig. 26b), suggesting that there has been a bony caudal keel similar to, but smaller than, those of Sardini (Fig. 28).

Only one species is known from the former USSR, which is described below. Remaining species are from the London Clay of England (Casier 1966; Monsch 2005).

†*Eocoelopoma portentosum* Bannikov, 1985
(Fig. 26)

1985 †*Eocoelopoma portentosa* Bannikov, p. 41, pl. 4, fig. 6, pl. 5, fig. 1, text-figs. 18–20a.

1997 †*Eocoelopoma portentosa* Ban. Bannikov & Parin, p. 134 (name only).

2000b †*Eocoelopoma portentosa* Ban. Monsch, p. 162, figs. 7.68, 7.69.

2005 †*Eocoelopoma portentosa* Ban. Monsch, p. 469 (name only)

2006 †*Eocoelopoma portentosum* Ban. Monsch, p. 886 (name only).

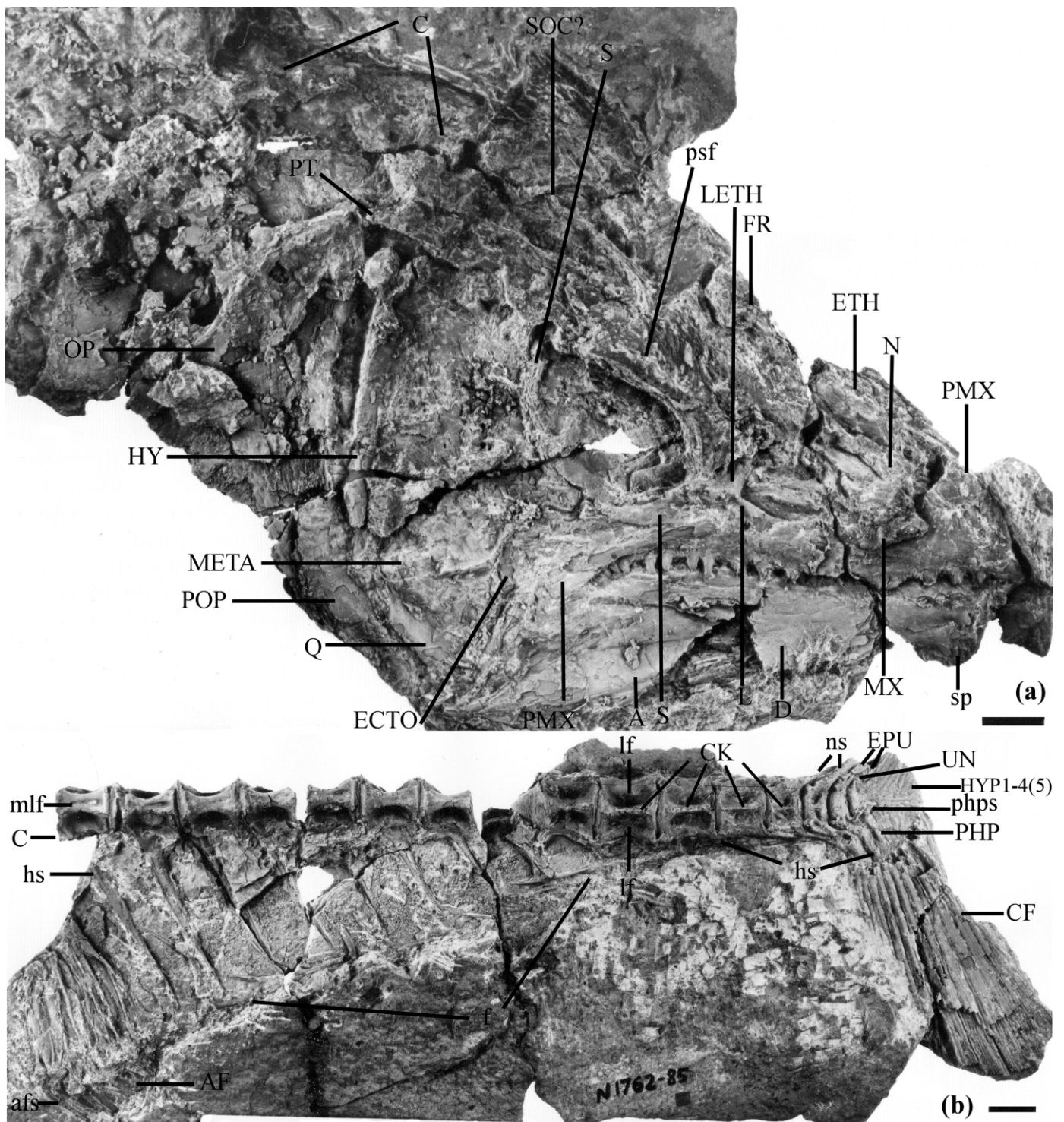

Figure 26 †*Eocoelopoma portentosum*, holotype, PIN 1762/85: (a) head region; (b) caudal region of axial skeleton; Uilya-Kushlyuk, Turkmenistan; Thanetian. Scale bars=10 mm. Abbreviations: A=angular; AF=anal fin; afs=anal-fin spine; C=centrum; CF=caudal fin; CK=caudal keel; D=dentary; ECTO=ectopterygoid; EPU=epural; ETH=ethmoid; f=finlets; FR=frontal; hs=haemal spine; HY=hyomandibular; HYP=hypural; L=lachrymal; LETH=lateral ethmoid; lf=lateral fossa; META=metapterygoid; mlf=mid-lateral fossa; MX=maxilla; N=nasal; ns=neural spine; OP=operculum; PHP=parhypural; phps=parhypurapophysis; PMX=premaxilla; POP=preoperculum; psf=postero-superior fossa; PT=pteroitic; Q=quadrate; S=sclerotic; SOC=m supraoccipital crest; sp=symphysial process of dentary; UN=uroneural.

2010 †*Eocoelopoma portentosum* Ban. Bannikov, p. 141, pl. XXIV, fig. 1, text-fig. 77.

Holotype. PIN 1762/85 (Fig. 26).

Type locality. Uilya-Kushlyuk, Turkmenistan; upper Palaeocene (Thanetian, lower part of Danata Svita).

Diagnosis. Jaw articulation in a relatively posterior position. Caudal end of retroarticular placed caudal of posterior

margin of orbit. Large ascending process on premaxilla, anterior margin of preoperculum relatively straight.

Hypodigm. Two specimens from the type locality, in PIN.

Description. Estimated standard length about 500 mm. Cranium of holotype 77 mm long, teeth slender, smooth, elongate and sharply pointed and all about the same size (~4 mm long). Lachrymal probably be shorter than length of

orbit (Fig. 26a) but apparently damaged. More details in Bannikov (1985).

Remarks. This species is known as †*Eocoelopoma portentosa*. Woodward (1901) apparently intended the gender of this genus to be neutral, despite the feminine ending of the name, considering his combination †*Eocoelopoma curvatum* Woodward, 1901. Bannikov (2010) already adopts this gender.

†*E. portentosum* is so far the only species of its genus of which the postcranial skeleton is known. The holotype consists of several associated fragments. The anterior part consists of the skull and a few precaudal vertebrae. The posterior fragment contains the complete caudal section of the postcranial skeleton. The middle section of the vertebral column is missing. Bannikov's (1985, text-fig. 18a) figure of †*E. portentosum* showed a reconstructed individual with 38 vertebrae (including the urostyle) and mentioned that the species has about 40 vertebrae. The exact number of vertebrae is unknown, but we accept Bannikov's (1985) estimate of ca. 40 vertebrae.

Genus †*Palaeothunnus* Bannikov, 1978

Type species. †*Palaeothunnus parvidentatus* Bannikov, 1978, p. 48, by monotypy and original designation.

Diagnosis. Relatively small teeth (Fig. 27a, b). 41 (20+21) vertebrae. Body covered by moderately-sized scales. Scales slightly larger (Fig. 27a) in pectoral region (no corselet). Neural and haemal spines under rather blunt angle with vertebral column. Second dorsal fin with one rigid spine and 14–16 soft rays. Anal fin with two spines and 11–12 rays. Pterygiophores with slight S-like curvature. Twelve dorsal and 10–11 anal finlets (most probably 11).

Other distinguishing characters. Short ascending process on premaxilla (Fig. 27a, b). hypurals 1–2 and 3–4 (–5) respectively fused together into two hypural plates (Fig. 27e). Median lepidotrichia of caudal fin not widened. Uroneural not fused to hypural plate. Number of epurals uncertain; only one observed in poorly preserved caudal skeletons.

†*Palaeothunnus parvidentatus* Bannikov, 1978 (Fig. 27)

1978 †*Palaeothunnus parvidentatus* Bannikov, p. 80, figs. 1, 2.

1980 †*Palaeothunnus parvidentatus* Ban. Danil'chenko, p. 155, text-fig. 50.

1985 †*Palaeothunnus parvidentatus* Ban. Bannikov, p. 48, pl. 5, fig. 4, pl. 6, fig. 2, text-figs. 20b, 23.

1997 †*Palaeothunnus parvidentatus* Ban. Bannikov & Parin, p. 134 (name only).

2000b †*Palaeothunnus parvidentatus* Ban. Monsch, p. 115, fig. 7.25.

2010 †*Palaeothunnus parvidentatus* Ban. Bannikov, p. 143, pl. XXIV, fig. 2.

Holotype. PIN 3363/20 (Fig. 27a, b).

Type locality. Uilya-Kushlyuk, Turkmenistan; upper Palaeocene (Thanetian, lower part of Danata Svita).

Diagnosis and other distinguishing characters. As for genus.

Hypodigm. Eleven specimens (mostly fragments) from the type locality in PIN.

Description. First dorsal fin with 14–16 spines. Caudal fin with 34 hypurostegic lepidotrichia, including 17 principal rays. Pectoral fin with 15–17 (17–19 in Bannikov, 1985) rays. More details in Bannikov (1978, 1985), our current generic diagnosis and other distinguishing characters.

Tribe Sardini Starks, 1910

Remarks. According to Monod (1968), *Sarda sarda* has only one epural. Currently, it is widely accepted that all Recent

scombrids have two epurals (e.g. Collette *et al.* 1984). However, following Monod, fossil Sardini are normally shown with one epural (Bannikov 1985, fig. 25, where it is called stegural). In Sardini, the neural spine of the second preural vertebrate is strongly reduced and is loosely connected to a large first epural (Collette & Chao 1975). In fossils, the border between this reduced neural spine and the epural may be blurred, thus giving the impression that the vertebra contains a long neural spine and that there is only one epural.

Genus *Gymnosarda* Gill, 1862

Type species. *Thynnus unicolor* Rüppell, 1838, p. 40, by monotypy and original designation.

Diagnosis. Hypural plate short, contains fused-in parhypural. Posterior process of pelvic plate single and large.

Other distinguishing characters. Size of caudal notch in hypural plate varies, sometimes notch is absent (see Monsch 2000a).

†*Gymnosarda prisca* Monsch, 2000a (Fig. 29)

non1982 †*Scomberomorus saevus* Bann. Bannikov, p. 135 (*pro parte*).

non1985 †*Scomberomorus saevus* Bann. Bannikov, p. 37, pl. 4, fig. 5 (*pro parte*).

2000a †*Gymnosarda prisca* Monsch, p. 75, figs. 1A, B, 2A.

2000b †*Gymnosarda prisca* Monsch. Monsch, p. 122, fig. 7.31.

2005 †*Gymnosarda prisca* Monsch. Monsch, p. 455, fig. 9a, b.

2010 †*Gymnosarda prisca* Monsch. Bannikov, p. 145, text-fig. 78.

Holotype. BMNH P6485.

Type locality. Sheppey, England; lower Eocene (Ypresian, London Clay).

Diagnosis. Hypural plate proportionally shorter than in other, fossil and Recent, species of *Gymnosarda*. In the holotype, the length of the plate without the urostyle fits 2.3 times into its height. In a specimen of *Gymnosarda unicolor* (Rüppell, 1838) that Monsch (2000b) uses for comparison (BMNH 1934.3.31), this ratio is 2.1.

Other distinguishing characters. Hypural plate large with large caudal notch (small or absent in other species).

Description. See Monsch (2000b).

Hypodigm. Besides the holotype, there is one more specimen, which is from the Mangyshlak peninsula, Kazakhstan (Monsch 2000a mistakenly stated that the specimen originates from Turkmenistan), from the middle Eocene (Bartonian, Shorym Svita) in PIN (Fig. 29).

Remarks. The two identical hypural plates that form the hypodigm are from remote areas of different geological provenances. Thus, it is possible that new specimens could disprove the validity of the species. We are, however, confident of the generic classification of these fossils. The taxonomic characters of caudal skeletons are valuable, provide excellent diagnostic characters for genera and have proven their value in determining scombroid phylogenetic relationships (see e.g. Uyeno & Fujii 1975; Carpenter *et al.* 1995; Monsch 2000a).

Genus *Sarda* Cuvier, 1829

Type species. *Scomber sarda* Bloch, 1793, p. 44, by monotypy and tautonymy.

Diagnosis. The vomerine teeth reduced in size and number or absent. 38–55 vertebrae (including fossil forms; the smallest amount of vertebrae in Recent forms reported is 42: see

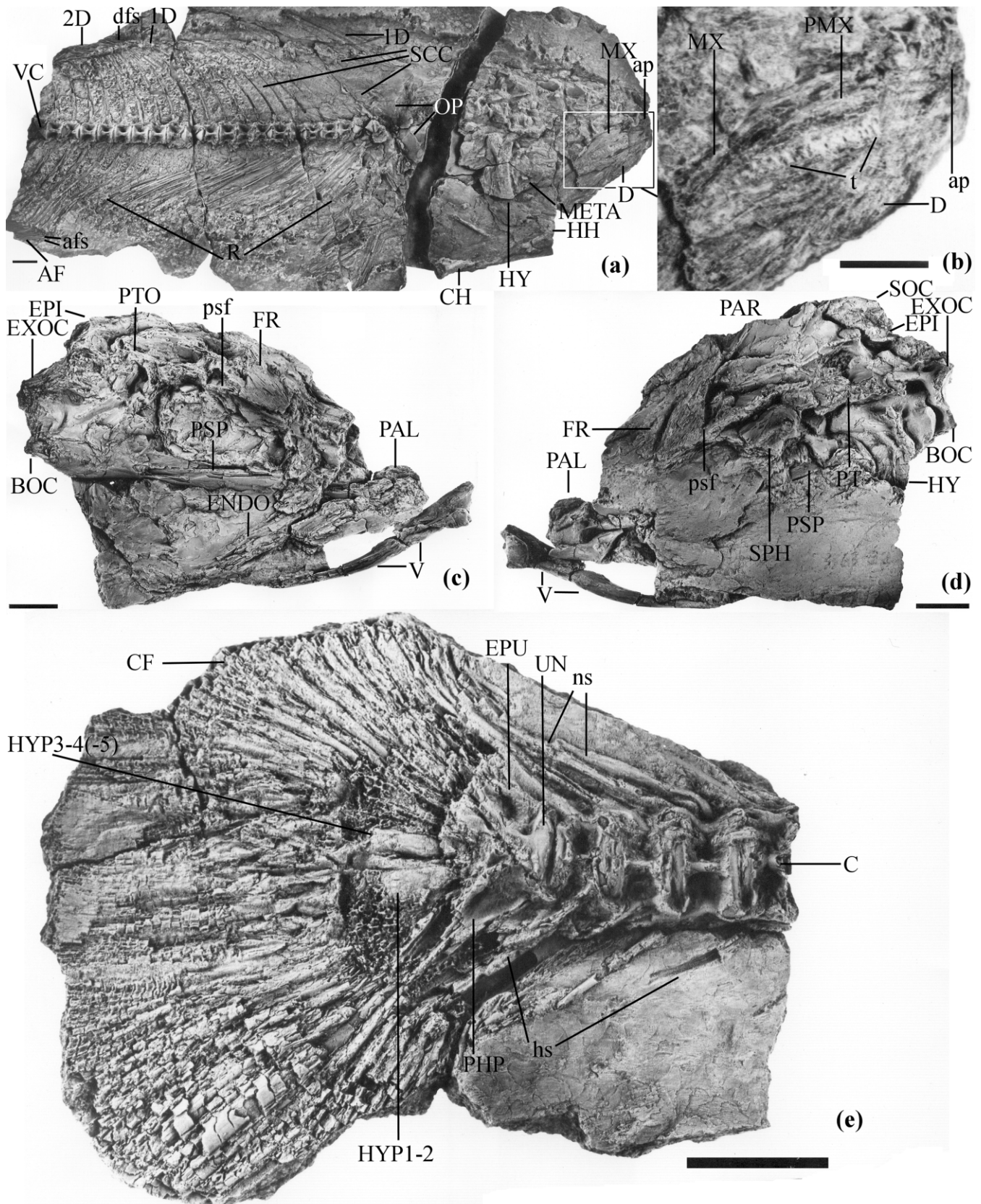

Figure 27 †*Palaeothunnus parvidentatus*, Uilya-Kushlyuk, Turkmenistan; Thanetian: (a) and (b) holotype, PIN 3363/20: (a) overview, boxed area enlarged in Fig. b; (b) detail of jaws and teeth. (c) and (d) cranium, PIN 3363/22: (c) right side; (d) left side. (e) tail region, PIN 3363/21. Scale bars=10 mm. Abbreviations: 1D=first dorsal fin; 2D=second dorsal fin; AF=anal fin; afs=anal-fin spine; ap=ascending process of premaxilla; BOC=basioccipital; C=centrum; CF=caudal fin; CH=ceratohyal; D=dentary; dfs=dorsal-fin spine; ENDO=endopterygoid; EPI=epiotic; EPU=epural; EXOC=exoccipital; FR=frontal; HH=hypohyal; hs=haemal spines; HY=hyomandibular; HYP=hypural; META=metapterygoid; MX=maxilla; ns=neural spines; OP=operculum; PAL=palatine; PAR=parietal; PHP=parhypural; PMX=premaxilla; psf=postero-superior fossa; PSP=parasphenoid; PT/PTO=pteroptic; R=ribs; SCC=scale covering; SOC=supraoccipital crest; SPH=sphenotic; t=teeth; UN=uroneural; V=vomer; VC=vertebral column.

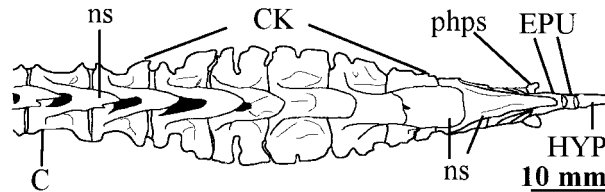

Figure 28 Sketch of caudalmost part of axial skeleton of *Sarda sarda* Bloch, 1793, based on USNM 26953. Abbreviations: C=centrum; CK=caudal keel; EPU=epurals; HYP=hypural; ns=neural spine; phps=parhypurapophysis.

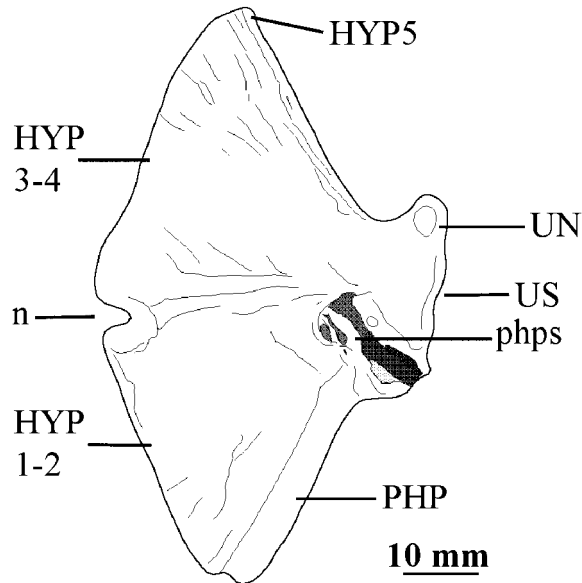

Figure 29 †*Gymnosarda prisca*, PIN 1877/4; Mangyshlak peninsula, Kazakhstan; Ypresian. Modified from Monsch (2000a). Abbreviations: HYP=hypural; n=caudal notch; PHP=parhypural; phps=parhypurapophysis; UN=uroneural; US=urostyle.

Collette & Chao 1975). Two cephalic intermuscular bones. Swim bladder absent. First dorsal fin with 15–23 spines. Bony caudal keel comparatively wide (Figs 28, 30a–b) and the hypural plate without caudal notch (Fig. 31).

Other distinguishing characters. No bony plates on tongue. Dentary and premaxilla with comparatively large and conical teeth. Opercular bones not elongated. Parhypural autogenous.

†*Sarda rara* Bannikov, 1979a
(Fig. 30)

non1960 †*Thunnus abchasicus* Dan. Danil'chenko, p. 149 (*pro parte*), pl. 16, fig. 3.

1979a †*Sarda rara* Bannikov, p. 98, fig. 1.

1985 †*Sarda rara* Ban. Bannikov, p. 52, pl. 6, figs 3, 4, text-figs 24, 25a.

1997 †*Sarda rara* Ban. Bannikov & Parin, p. 138 (name only).

2000b †*Sarda rara* Ban. Monsch, p. 128, fig. 7.37.

2010 †*Sarda rara* Ban. Bannikov, p. 144, pl. XXV, fig. 2.

Holotype. PIN 3363/18 (Fig. 30c).

Type locality. Belaya River near Abadzekhskaya village, N Caucasus, Russia; lower Oligocene (Rupelian, Pshekha Horizon).

Diagnosis. 40–41 (21–22+19) vertebrae. Second dorsal fin with one spine followed by 14–15 rays. Pectoral fin with 28 lepidotrichia.

Other distinguishing characters. First dorsal fin with 16 rays. Anal fin with two spines and 12 rays. 7–8 dorsal finlets. Only seven anal finlets can be confirmed, unlikely to be more,

because difference in number between dorsal and anal finlets normally at most one.

Hypodigm. Six specimens from the type locality, one from N Ossetia, and one from the Pshekha River, all from Caucasian Russia, of the same stratigraphic provenance as the holotype, in PIN.

Description. Maximum body depth 25–27% of standard length. Head length 30–33% of standard length. Caudal fin deeply forked. More details in Bannikov (1979a, 1985).

†*Sarda remota* Danil'tshenko, 1980
(Fig. 32)

non1960 †*Scomber voitesii* Paucá. Danil'chenko, p. 152 (*pro parte*), pl. 22, fig. 1.

1980 †*Sarda remota* Danil'chenko, p. 158, pl. 18, fig. 3, text-fig. 51.

1985 †*Sarda remota* Dan. Bannikov, p. 55, pl. 7, figs. 1–3, text-figs. 26, 27.

1997 †*Sarda remota* Dan. Bannikov & Parin, p. 139 (name only).

2000b †*Sarda remota* Dan. Monsch, p. 129, fig. 7.38.

2010 †*Sarda remota* Dan. Bannikov, p. 144, pl. XXIV, fig. 3.

Holotype. PIN 1413/45 (Fig. 32a).

Type locality. Belaya River at Abadzekhskaya settlement, N Caucasus, Russia; upper Oligocene (Chattian, Kalmyk Horizon).

Diagnosis. 41–42 (22–23+19) vertebrae.

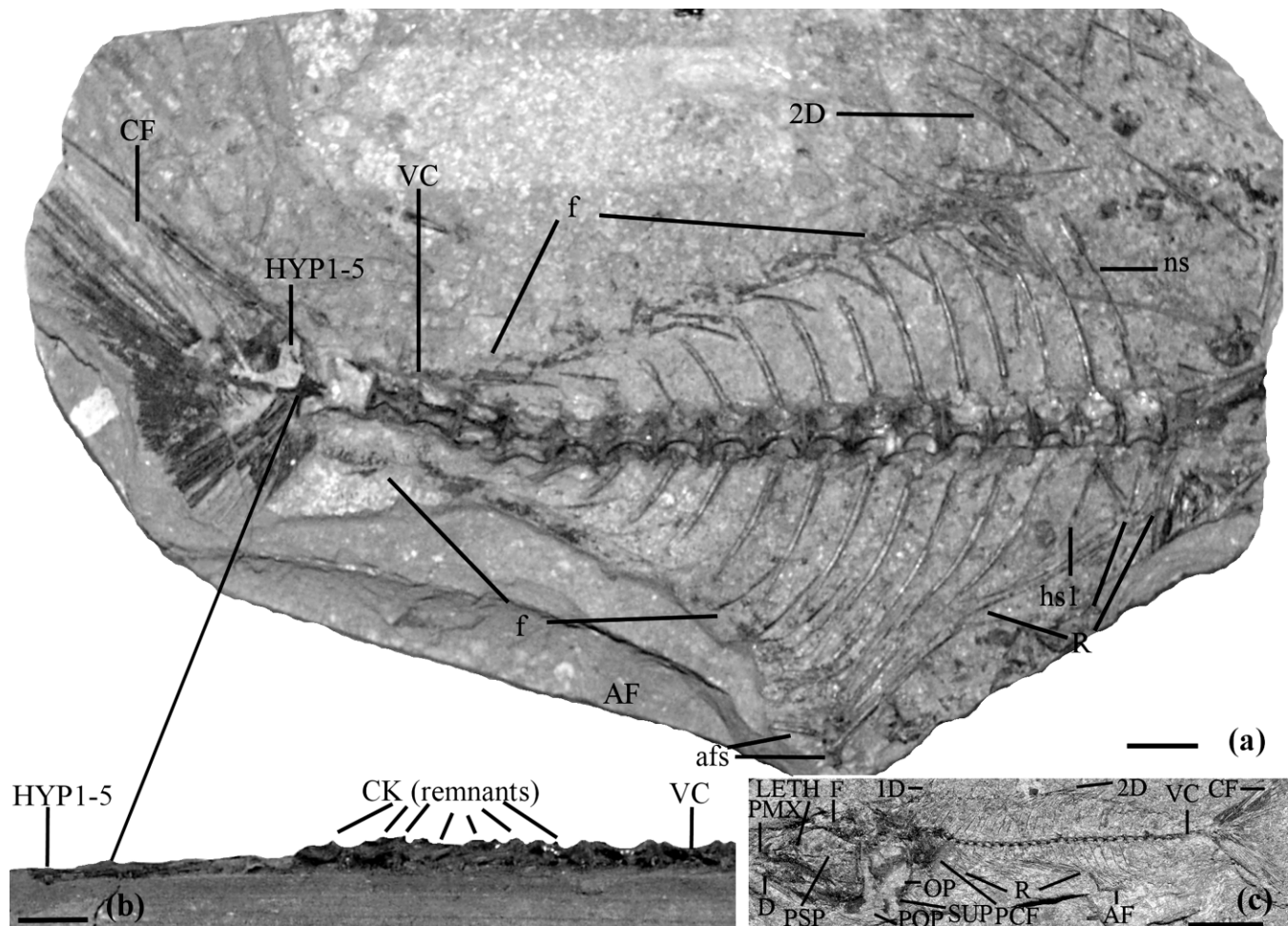

Figure 30 †*Sarda rara*, N Caucasus, Russia; Rupelian: (a) PIN 483/2, N Ossetia; (b) ventral view of specimen in (a), showing protruding vestiges of lateral caudal keel; (c) holotype, PIN 3363/18, river Belaya, Adygea. Scale bars=10 mm. Abbreviations: 1D=first dorsal fin; 2D=second dorsal fin; AF=anal fin; afs=anal-fin spine; CF=caudal fin; CK=caudal keel; D=dentary; F=frontal; f=finlets; hs1=first haemal spine; HYP=hypural; LETH=lateral ethmoid; ns=neural spine; OP=operculum; PCF=pectoral fin; PMX=premaxilla; POP=preoperculum; PSP=parasphenoid; R=ribs; SUP=suboperculum; VC=vertebral column.

Other distinguishing characters. First dorsal fin with 15–16 spines, Second dorsal fin with one spine and 11–12 rays. Anal fin with two rigid spines and 12–13 soft rays. Eight dorsal and 7–8 anal finlets. Pectoral fin with 27 rays.

Hypodigm. Three specimens from the type locality, one from the bank of the river Belaya, near the mouth of the River Fyuntv (the holotype and PIN 3363/89, Fig. 32b), and one from the bank of the river Gumista, Abkhazia, all from the same stratigraphic provenance as the holotype, in PIN.

Description. Maximum body depth 20–23% of standard length. Head length 25–28% of standard length. More details in Danil'chenko (1980) and Bannikov (1985).

†*Sarda memorabilis* Danil'tshenko, 1980
(Figs 31, 33)

1980 †*Sarda memorabilis* Danil'chenko, p. 159, pl. 18, fig. 4.

1985 †*Sarda memorabilis* Dan. Bannikov, p. 58, pl. 7, fig. 4, pl. 8, fig. 1, text-figs. 25b, 28.

1997 †*Sarda memorabilis* Dan. Bannikov & Parin, p. 140 (name only).

2000b †*Sarda memorabilis* Dan. Monsch, p. 128, fig. 7.36.

2010 †*Sarda memorabilis* Dan. Bannikov, p. 145, pl. XXV, fig. 1.

Holotype. PIN 3363/91 (Fig. 33).

Type locality. Islamdagh Mount at the river Sumgait, Azerbaijan; lower Miocene, upper Maykopian (lower Burdigalian, Sakaraul Horizon).

Diagnosis. Vertebrae 39–40 (21+18–19) in number.

Other distinguishing characters. First dorsal fin with 15–16 spines, second dorsal fin with one spine and 12–13 rays, anal fin with two spines and 11–12 rays. Eight or nine dorsal and seven anal finlets. Pectoral fin with 16–18 lepidotrichia.

Hypodigm. Four specimens from the type locality, three from the bank of the river Chyornaya, N Ossetia, N Caucasus, Russia; five specimens from Cape Tarkhan, the Crimea, Ukraine; one from the river Urup near the village Otradnaya, and two from near Shirvanskaya settlement, all from the same stratigraphic provenance as the holotype, in PIN.

Description. Maximum body depth 22–25% of standard length. Head length 32–35% of standard length. Caudal fin deeply forked, with 27 or 32 rays, including 17 principal rays (counted in two specimens). More details in Danil'chenko (1980) and Bannikov (1985).

Remarks. The collection number of the specimen figured by Bannikov (2010: pl. XXV, fig. 1) is PIN 3974/13 rather than PIN 3974/10, as erroneously indicated in the figure caption.

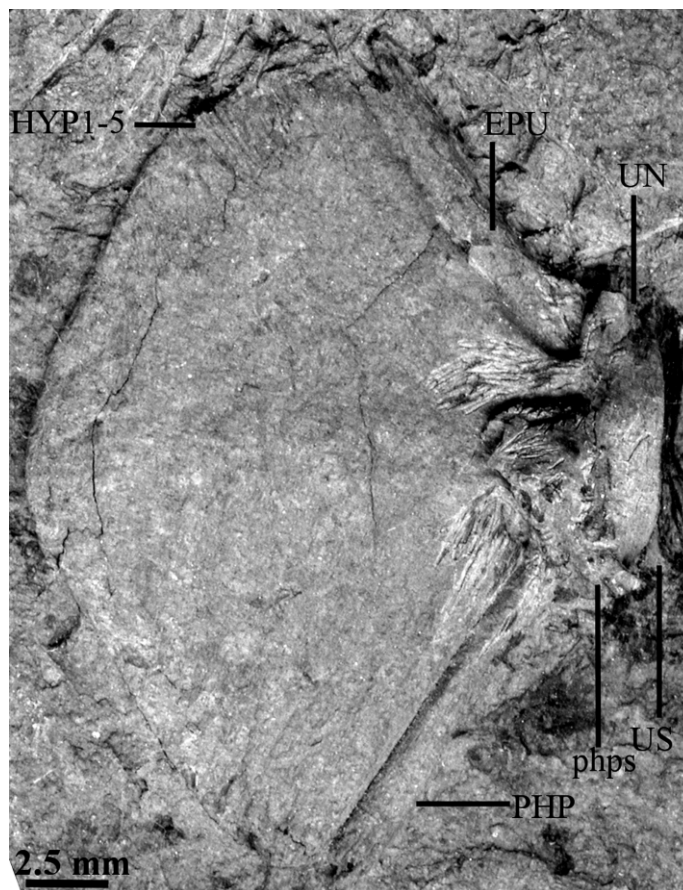

Figure 31 †*Sarda memorabilis*, PIN 3363/92, caudal complex, River Urup, N Caucasus, Russia; Burdigalian. The dorsal part is damaged, so the exact location of the incompletely fused-in fifth hypural cannot be assessed. Abbreviations: EPU=eppural; HYP=hypural; PHP=parhypural; phps=parhypurapophysis; UN=uroneural; US=urostyle.

Tribe Thunnini Starks, 1910
Genus *Thunnus* South, 1845

Type species. *Scomber thynnus* Linnaeus, 1758, p. 297, by being a replacement name.

Diagnosis. Body deep and fusiform. Small teeth. Frontoparietal fenestra and pineal window present. First vertebra completely sutured to skull. Preural vertebrae 2–3 strongly shortened. Recent species with 39 vertebrae. Fossil species possibly of *Thunnus* have less or more vertebrae (see below). First dorsal fin with 11–14 spines, second dorsal fin with 12–16 rays. 7–10 finlets both above and below. Pectoral fin with 30–36 rays.

Other distinguishing characters. Posterior process of pelvic plate single and short. Dorsal fins close to one another. Body covered by minute scales behind anterior corselet of larger scales.

Remarks. The following two fossil species are provisionally attributed to the genus *Thunnus* because they possess some, but not all, diagnostic features of that genus. If these species belong to *Thunnus*, then it can be concluded that (certain) extinct species possessed spines in the second dorsal and anal fin (see species accounts below), a trait that has disappeared in Recent species. This would imply as well that within this genus there is a crown group, and that these fossil species are outside of it.

†*Thunnus* *abchasicus* Daniltshenko, 1951

1951 †*Thunnus abchasicus* Danil'chenko, p. 881, text-fig. 1.
1960 †*Thunnus abchasicus* Dan. Danil'chenko, p. 149, pl. 16, fig. 4, text-fig. 4 (excl., pl. 16, fig. 3).

1964 †*Thunnus abchasicus* Dan. Danil'chenko, pl. 11, fig. 4.
non 1978 †*Thunnus abchasicus* Dan. Ciobanu, p. 190, pl. 2, fig. 3.

1980 †*Thunnus abchasicus* Dan. Danil'chenko, p. 156.
1985 †*Thunnus abchasicus* Dan. Bannikov, p. 61, text-fig. 29.
1997 †*Thunnus abchasicus* Dan. Bannikov & Parin, p. 135 (name only).
2010 †*Thunnus abchasicus* Dan. Bannikov, p. 146, pl. XXV, fig. 5.

Holotype. AMRS 167–168.

Type locality. Gumista River near Sukhumi, Abkhazia; middle Eocene, (Kuma Horizon).

Diagnosis. 40–41 (18+22–23) vertebrae. Pelvic fin anterior of pectoral.

Other distinguishing characters. First dorsal fin with 11–12 spines, second dorsal fin with one spine and 12–13 rays, anal fin with two spines and 11–12 rays. Nine or ten dorsal, and seven or eight anal finlets. Pectoral fin with 33–36 lepidotrichia.

Hypodigm. In PIN, besides the holotype, six fragmentary specimens from the river Pshekha, N Caucasus; middle Eocene, Kuma Horizon.

Description. Maximum body depth 31–32% of standard length. Head length 28–30% of standard length. More details in Danil'chenko (1960) and Bannikov (1985).

†*Thunnus* *secretus* Bannikov, 1979b

1979b †*Thunnus secretus* Bannikov, p. 103, text-fig. 4.
1985 †*Thunnus secretus* Ban. Bannikov, p. 63, pl. 8, fig. 4, text-fig. 30.

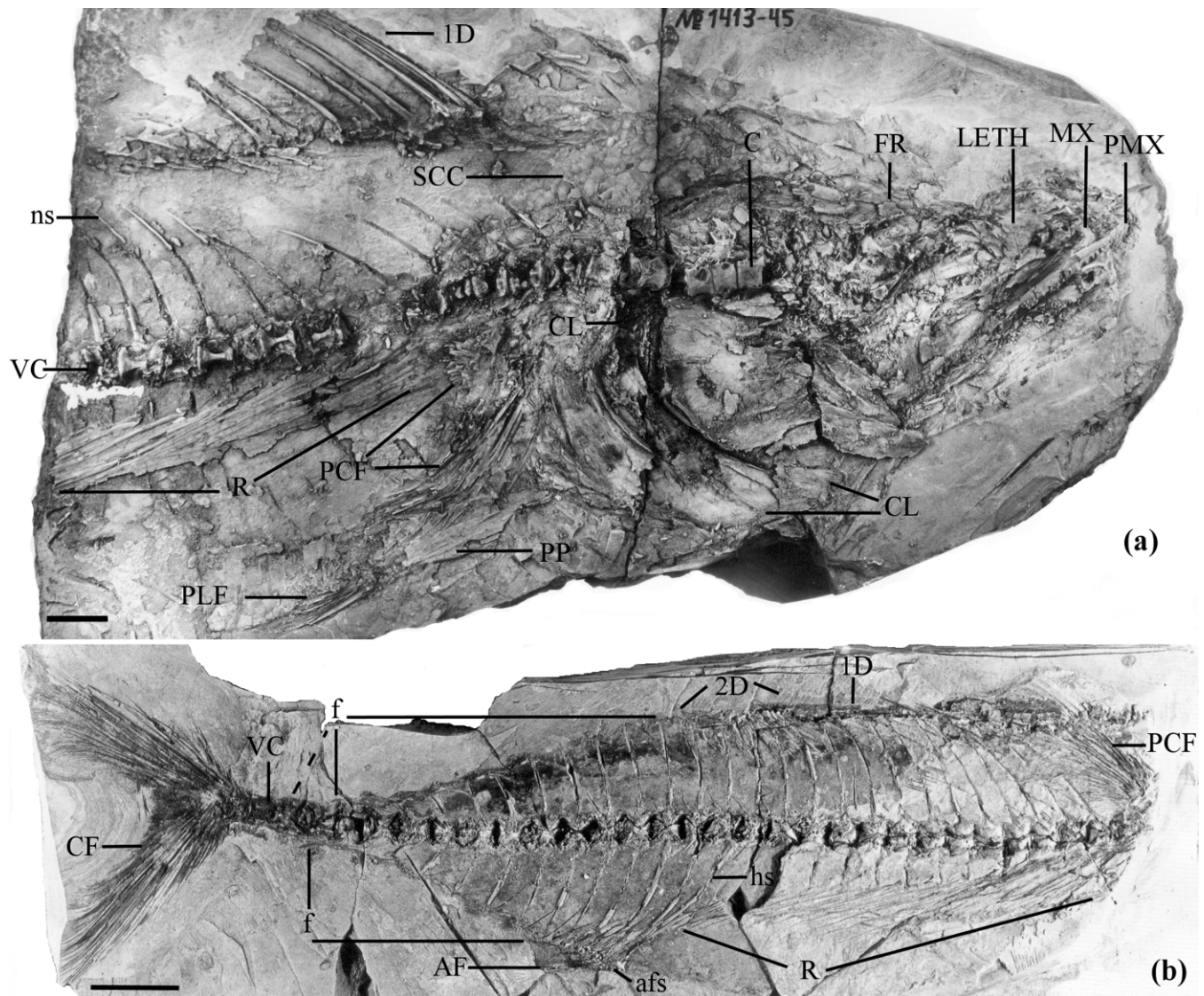

Figure 32 †*Sarda remota*, River Belaya, N Caucasus, Russia; Chattian: (a) holotype, PIN 1413/45; (b) PIN 3363/89. Scale bars=20 mm. Abbreviations: 1D=first dorsal fin; 2D=second dorsal fin; AF=anal fin; afs=anal-fin spine; C=centrum; CF=caudal fin; CL=cleithrum; f=fangs; FR=frontal; hs=haemal spine; LETH=lateral ethmoid; MX=maxilla; ns=neural spine; PCF=pectoral fin; PLF=pelvic fin; PMX=premaxilla; PP=pelvic plate; R=ribs; SCC=scale covering; VC=vertebral column.

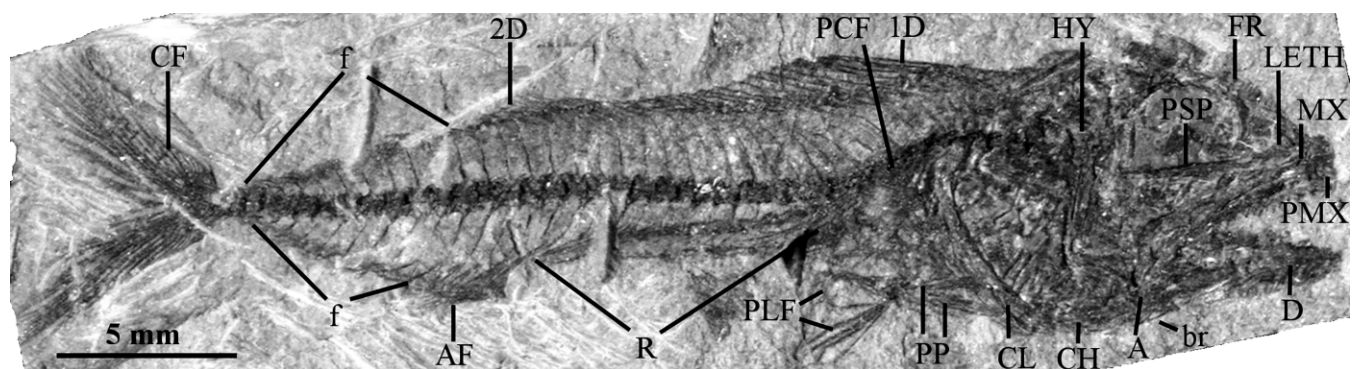

Figure 33 †*Sarda memorabilis*, holotype, PIN 3363/91, Islamdagh Mount at the river Sumgait, Azerbaijan; Burdigalian. Abbreviations: 1D=first dorsal fin; 2D=second dorsal fin; A=angular; AF=anal fin; br=branchiostegal rays; CF=caudal fin; CH=ceratohyal; CL=cleithrum; D=dentary; f=finlets; FR=frontal; HY=hyomandibular; LETH=lateral ethmoid; MX=maxilla; PCF=pectoral fin; PLF=pelvic fin; PMX=premaxilla; PP=pelvic plate; PSP=parasphenoid; R=ribs.

2010 †*Thunnus secretus* Ban. Bannikov, p. 147, pl. XXV, fig. 3.

Holotype. TMRS P-75.
Type locality. Verkhovina Bystraya village, Transcarpathians, W Ukraine; upper Oligocene, Krosno Series.

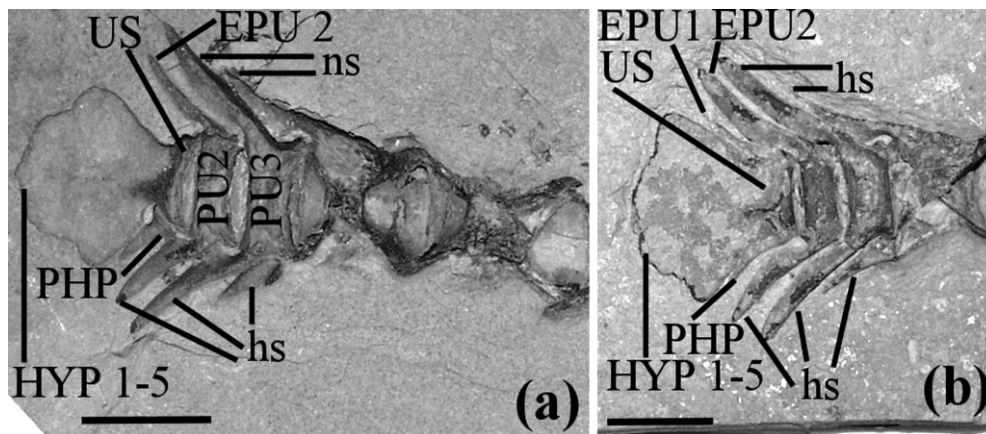

Figure 34 Thunnini †*incertae sedis*, river Belaya near Abadzekhskaya settlement, N Caucasus, Russia; Rupelian: (a) PIN 3363/96; (b) PIN 3363/165. Scale bars=10 mm. Abbreviations: EPU=epural; hs=haemal spine; HYP=hypural; ns=neural spine; PHP=parhypural; PU=preural vertebra; US=urostyle.

Diagnosis. 36–37 (17–18+19) vertebrae. Pelvic fin slightly anterior of pectoral fin.

Other distinguishing characters. First dorsal fin with 12–13 spines, second dorsal fin with one spine and 10–11 rays, anal fin with two spines and 12–13 rays. 7–8 dorsal, and seven anal finlets.

Hypodigm. Besides the holotype, one specimen from the type locality in the collection of the Uzhgorod University.

Description. Maximum body depth 28–30% of standard length. Head length 27–28% of standard length. More details in Bannikov (1979b, 1985).

†*Incertae sedis* sp.
(Fig. 34)

1985 Thunninae †gen. indet. Bannikov, p. 66, pl. 8, fig. 5.

1991 †*Glyptorhynchus* sp. Pharissat, p. 71, text-fig. 61.

1997 Thunninae †gen. indet. Bannikov & Parin, p. 138 (name only).

2000b Thunnini †gen et sp. indet. Monsch, p. 136, fig. 7.42.

2010 Thunninae †gen. indet. Bannikov, p. 147 (name only).

Diagnosis. Preural vertebrae 2–3 abruptly shortened.

Hypodigm. Two specimens from the river Belaya near Abadzekhskaya settlement, N Caucasus, Russia; lower Oligocene, Rupelian (Pshekhha Horizon), in PIN (Fig. 34). A similar fragment was described by Pharissat (1991) from the Rupelian of France (Froidefontaine) as †*Glyptorhynchus* sp.

Description. Only last few vertebrae with caudal complex found. Anterior of caudal complex, centrum hourglass-shaped, medially constricted, clearly longer than deep. Second and third preural vertebrae disc-shaped, clearly deeper than long. Two autogenous epurals, of which the first reduced in size. Second epural similar in size to neural spine of third preural vertebra. Hypural plate with hypurals 1–5 fused together, without caudal notch, plate diamond-shaped with wavy distal outline (see Fig. 34). Parhypural small, autogenous, seemingly without parhypurapophysis.

Remarks. Thunninae *sensu* Bannikov (1985, 2010) include tribes Sardini and Thunnini. However, only in Thunnini is the shortening of preural vertebrae as abrupt as in these specimens. If these are tunas, they are unusual representants: the caudal skeleton is stiffened less than in other Thunnini, and no other thunnin lacks a parhypurapophysis on the parhypural. The hypural plate itself is remarkably small and its caudal outline is much more wavy than in other Thunnini. There is no known relative to which these fossils can be compared and

hence, in the absence of better material, it seems best to not assign them to any genus or species for now. Bannikov (1985) describes ‘Thunninae indet.’ on the basis of one specimen, PIN 3363/96. Based on its unusual shape for an adult, it could be thought that the fossil represents a juvenile specimen. However, in juvenile tunnies of similar sizes, the elements are not as strongly fused together as in this enigmatic fossil and the distal outline of the hypural plate is rather even (Potthoff 1975). Besides that, the subsequent discovery of an almost identical, similarly bizarre specimen (PIN 3363/165) makes it reasonable to assume that these caudal skeletons are complete and well preserved.

Tribe Scomberomorini Starks, 1910
Genus *Scomberomorus* Lacépède, 1802

Type species. *Scomberomorus plumieri* Lacépède, 1802 (= *Scomber regalis* Bloch, 1793, p. 38), by monotypy.

Diagnosis. Anterior margin of vomer spatulate rather than concave. Laterally compressed teeth. 40–56 vertebrae (including fossil forms, see below), first dorsal fin with 12–22 spines, second dorsal fin with 15–25 rays. Body covered by minute scales.

Other distinguishing characters. 6–11 dorsal and 5–12 anal finlets. Three paired, fleshy lateral keels near caudal fin. Vertebrae without mid-lateral fossae. Straight pterygiophores (which distinguishes them from †*Palaeothunnus*, which have curved ones).

†*Scomberomorus avitus* Bannikov, 1985
(Fig. 35)

1985 †*Scomberomorus avitus* Bannikov, p. 35, pl. 3, fig. 4; pl. 4, fig. 1, text-fig. 15.

1997 †*Scomberomorus avitus* Ban. Bannikov & Parin, 1997, p. 134 (name only).

2000b †*Scomberomorus avitus* Ban. Monsch, p. 117, fig. 7.26.

2010 †*Scomberomorus avitus* Ban. Bannikov, p. 140, pl. XXIII, fig. 4.

Holotype. PIN 1762/86 (Fig. 35a).

Type locality. Uilya-Kushlyuk, Turkmenistan; upper Palaeocene (Thanetian, lower part of Danata Svita).

Diagnosis. The lower jaw seemingly slightly protrudes beyond the upper jaw (Fig. 35a). Moderately long ascending process on premaxilla.

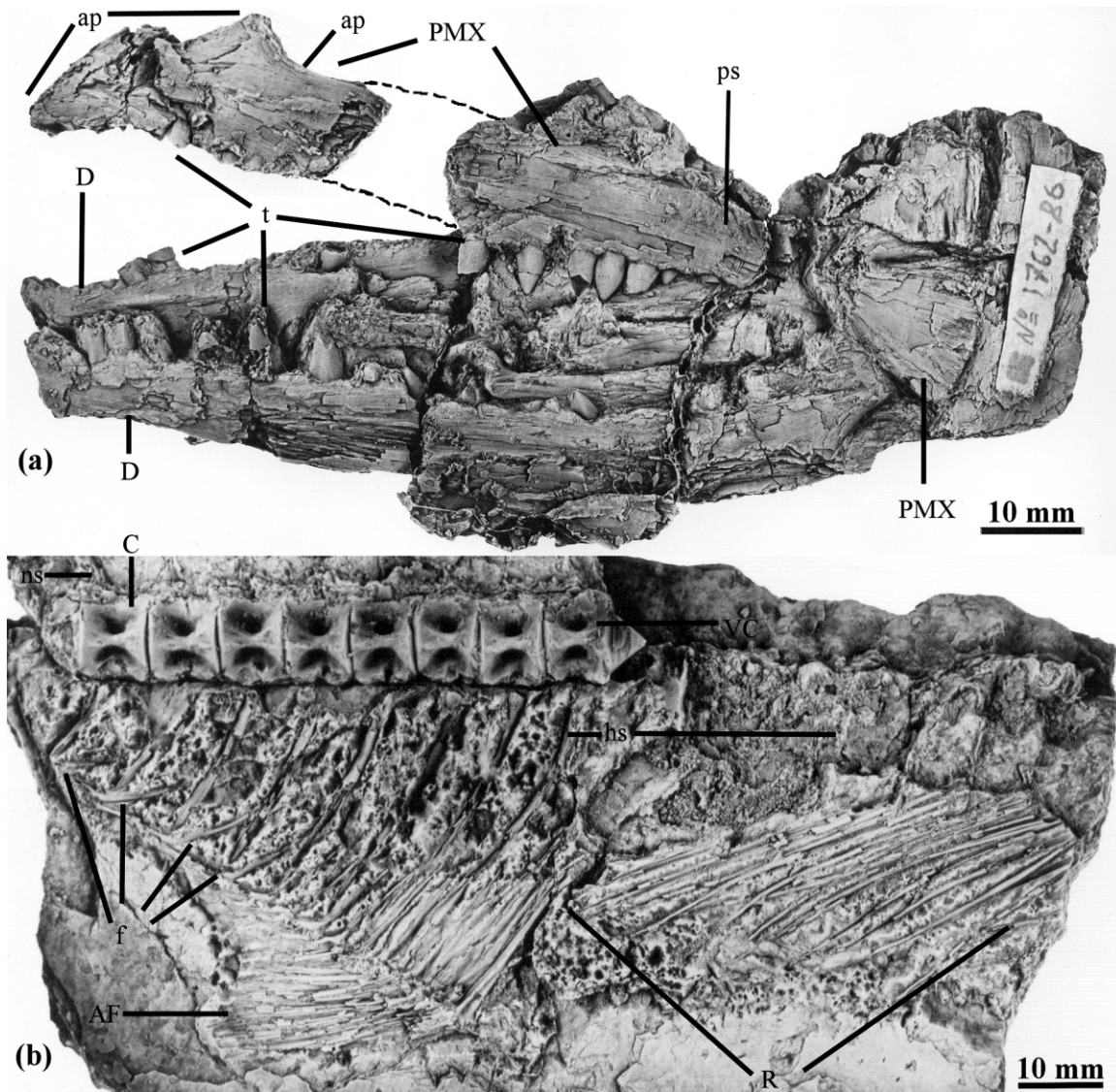

Figure 35 †*Scomberomorus avitus*, Uilya–Kushlyuk, Turkmenistan; Thanetian: (a) holotype, PIN 1762/86; (b) paratype, PIN 1762/87. Abbreviations: AF=anal fin; ap=ascending process of premaxilla; C=centrum; D=dentary; f=finlet; hs=haemal spine; ns=neural spine; PMX=premaxilla; ps=posterior shank of premaxilla; R=ribs; t=teeth; VC=vertebral column.

Other distinguishing characters. Total number of vertebrae estimated at ca. 40, making this species the one with the least vertebrae of its genus (compare with Collette & Russo, 1985). Dentary with about 15 teeth. Anal fin with 13 rays. Four finlets preserved (Fig. 35b). Obliterated hind part of the axial skeleton contained probably not more than two additional finlets.

Hypodigm. Four fragmentary specimens from the type locality, in PIN.

Description. Adding to diagnosis and other characters: length of holotypic mandible 91 mm. More details in Bannikov (1985).

†*Scomberomorus saevus* Bannikov, 1982
(Fig. 36)

- 1982 †*Scomberomorus saevus* Bannikov, p. 143, fig. 1.
1985 †*Scomberomorus saevus* Ban. Bannikov, p. 37, pl. 4, figs. 2, 4 (excl. fig. 5), text-fig. 16 (excl. text-fig. 17d, e).
1997 †*Scomberomorus saevus* Ban. Bannikov & Parin, p. 135 (name only).
2000b †*Scomberomorus saevus* Ban. Monsch, p. 117, fig. 7.27.
2010 †*Scomberomorus saevus* Ban. Bannikov, p. 140, pl. XXIII, fig. 5.

Holotype. PIN 1877/8 (Fig. 36a, b).

Type locality. Karagiye Depression, Mangyshlak peninsula, Kazakhstan; middle Eocene (Bartonian, Shorym Svita).

Diagnosis. 26–29 teeth in premaxilla, estimated fork length 2800 mm (by extrapolation from the largest remains, in comparison with ratios observed in Recent species in Collette & Russo 1985 – this would make *S. saevus* the largest species known).

Other distinguishing characters. Angle between ascending process and posterior shank of premaxilla about 35° (character probably does not convey phylogenetic signal, see Collette & Russo 1985). Jaw apparatus more robust than in other known species, but teeth are relatively smaller and more conical than in Recent *Scomberomorus*.

Hypodigm. Forty-five cranial fragments (e.g. prootic, Fig. 36c) and >100 vertebrae (mostly isolated) from the type locality, in PIN (see also remarks).

Description. Length of holotypic premaxilla 238 mm. More detailed descriptions in Bannikov (1982, 1985).

Remarks. The Recent *Scomberomorus lineolatus* (Cuvier, 1829), which has a premaxilla with a similarly sharp anterior angle, has a maximum fork length of only 800 mm, Collette & Russo 1985. The original hypodigm of †*S. saevus* (Bannikov

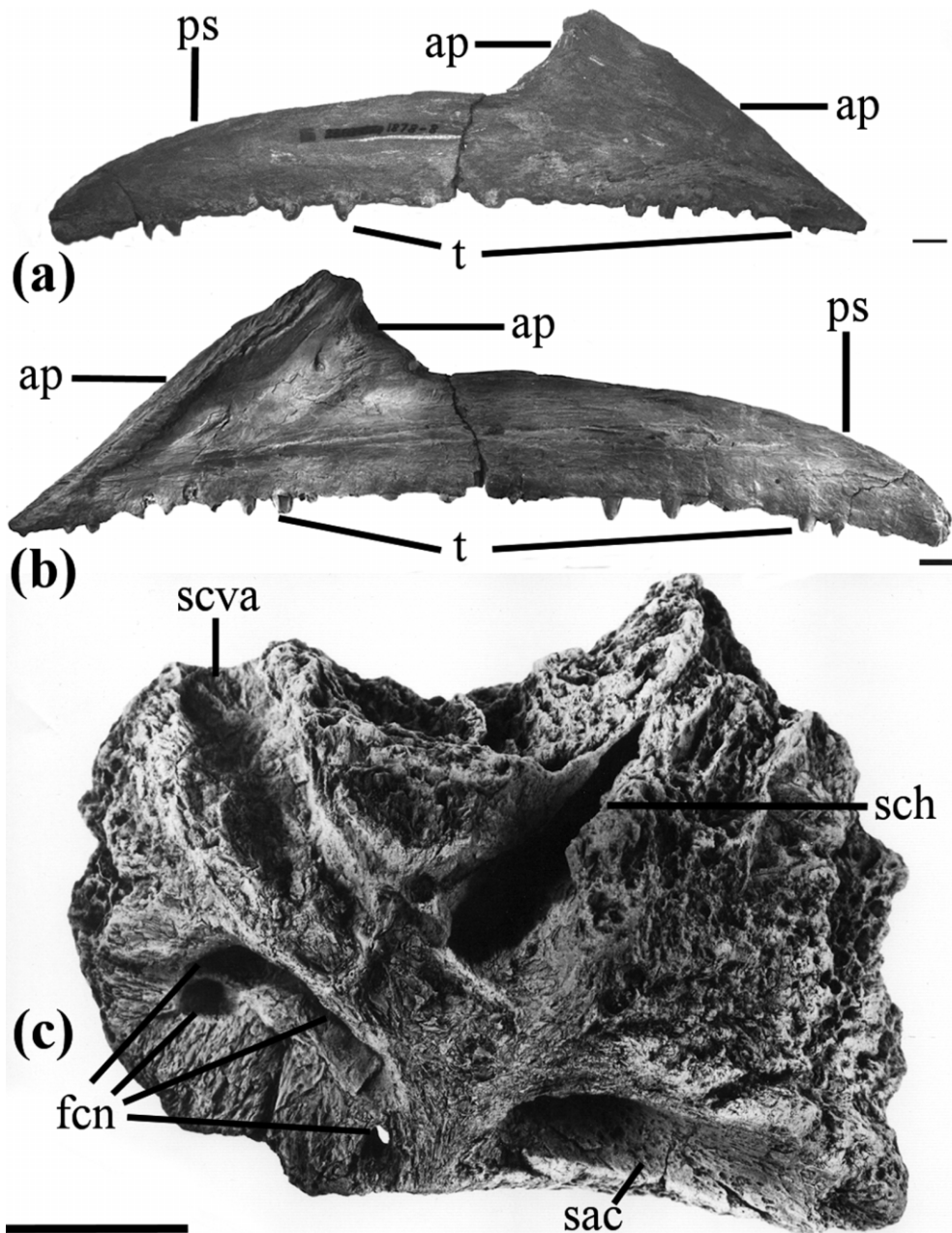

Figure 36 †*Scomberomorus saevus*, Mangyshlak peninsula, Kazakhstan; Ypresian: (a) and (b) holotype, right premaxilla, PIN 1877/8: (a) labial view, (b) lingual view; (c) fragment of right prootic (posterior end on the right), PIN 1877/9. Scale bars=10 mm. Abbreviations: ap=ascending process of premaxilla; fcn=foramina for cranial nerves; ps=posterior shank of premaxilla; sac=recess for sacculus; sch=recess for horizontal semicircular canal; scva=recess for anterior vertical semicircular canal; t=teeth.

1982) includes eight hypural plates that were included because of their superficial similarity to *Scomberomorus* and one another. These specimens require re-identification. Monsch (2000a) studied two of these plates; one of which (PIN 1877/4) was placed in the hypodigm of †*Gymnosarda prisca* and another (PIN 1877/2) was 'identified' as an unknown scombrid. Here, the latter is tentatively assigned to a new species of †*Neocybium* (see below). The collection number of the series of specimens, previously catalogued as PIN 1878, is now corrected to PIN 1877 (Bannikov 2010).

Genus †*Neocybium* Leriche, 1908

Type species. *Neocybium rostratum* Leriche, 1908, p. 379, by monotypy.

Diagnosis. Palatine toothed. Jaw teeth small, tightly packed, moderately compressed laterally. About 50 vertebrae.

Vertebrae 30–40, each with lateral fossae, along subsequent vertebrae clearly decreasing in size to eventually disappear (Leriche 1910). Parhypural and uroneural fused to hypural plate.

Other distinguishing characters. Uniserial teeth (†*Palaeocybium* Monsch, 2005, classified in Scomberomorini *cf* our taxonomy, is the only member of its tribe with a double tooth row).

†*Neocybium parvidentatum* sp. nov.
(Fig. 37)

1985 †*Neocybium* sp. Bannikov, p. 40, pl. 4, fig. 3.
non 1985 †*Scomberomorus saevus* Ban. Bannikov, text-fig. 17d, e.

1997 †*Neocybium* sp. Bannikov & Parin, p. 135 (name only).
2000a Scomberomorini indet. Monsch, fig. 2B.

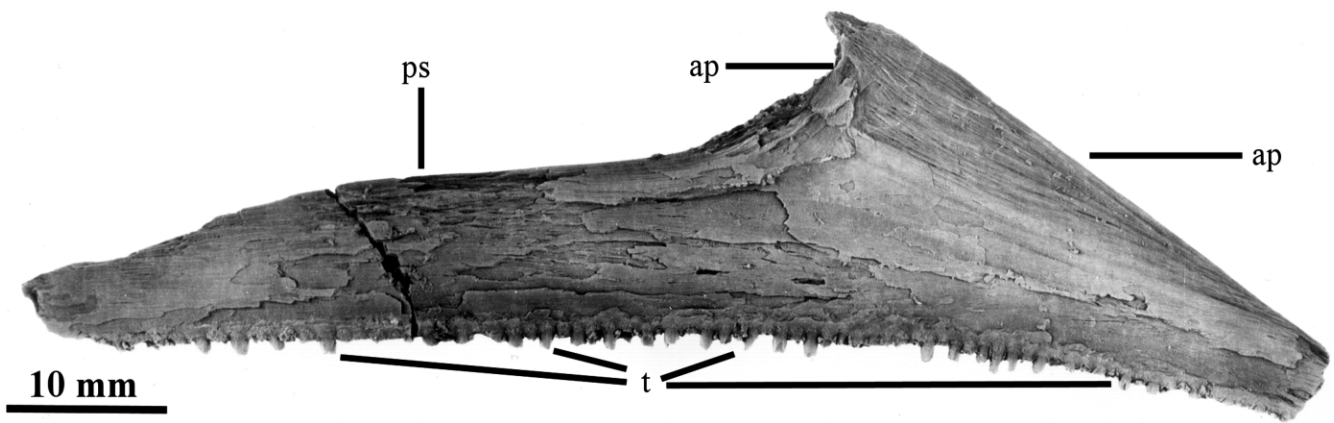

Figure 37 †*Neocybium parvidentatum*, holotype PIN 1877/5 (right premaxilla in labial view), Mangyshlak peninsula, Kazakhstan; Bartonian. Abbreviations: ap=ascending process; ps=posterior shank; t=teeth.

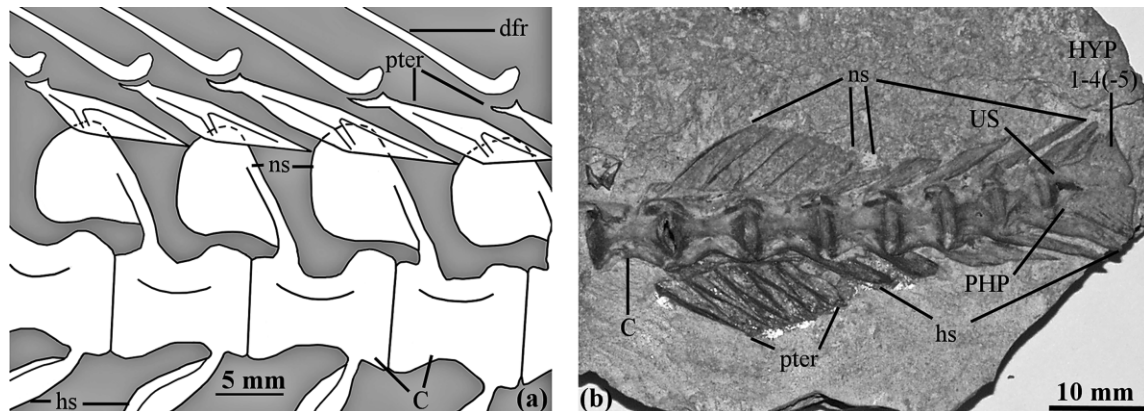

Figure 38 Apomorphies of †Palaeorhynchidae: (a) sketch of †*Palaeorhynchus zorzini* (Italy, Ypresian), showing the morphology of the dorsal-fin pterygiophores and neural spines just caudal of the midpoint of the vertebral column (vertebrae 31–34), modified after H.L. Fierstine's original sketch in Fierstine *et al.* (2008); (b) morphology of vertebral spines and caudalmost anal-fin pterygiophores of †*Homorhynchus colei* in PIN 3363/166; River Belaya, N Caucasus, Russia; Rupelian. Abbreviations: C=centrum; dfr=dorsal-fin ray; hs=haemal spine; HYP=hypural; ns=neural spines; PHP=parhypural; pter=pterygiophores; US=urostyle.

2000b Scomberomorinae indet. Monsch, p. 122, fig. 7.32b.
 2000b cf. *Acanthocybium* Monsch, p. 136, fig. 7.43
 2000b *Acanthocybiinae* gen. et sp. indet. Monsch, p. 140.
 2010 †*Neocybium* sp. Bannikov, p. 141 (name only).

Etymology. After the Latin *parvus* (small) and *dens* (tooth).

Holotype. PIN 1877/5 (Fig. 37), right premaxilla.

Type locality. Mangyshlak peninsula, W Kazakhstan; middle Eocene (Bartonian, Shorym Svita).

Diagnosis. Teeth smaller than in other known species and somewhat blunt-tipped (similar to dentition of *Acanthocybium*). At least 50 teeth in premaxilla.

Hypodigm. The holotype and perhaps the hypural plate PIN 1877/2 from the west border of Ustyurt plateau, Kazakhstan; same age as the holotype.

Description. First description in Bannikov (1985). Length of holotypic premaxilla 84 mm. Ascending process forming 45% of whole premaxilla. Length of hypural plate PIN 1877/2 39 mm, depth 67 mm. Hypural plate large with distinct caudal notch.

Remarks. This species differs from the mid-Oligocene Belgian †*Neocybium rostratum* Leriche, 1908 due to relatively smaller teeth. The hypural plate PIN 1878/2 shares apomorphic characters with those of †*N. rostratum* (see Leriche 1910), therefore it is tentatively assigned to the hypodigm of the new species.

Superfamily Xiphoidea Rafinesque-Schmaltz, 1810
 Family Palaeorhynchidae Günther, 1880

Remarks. All members of this family possess a remarkably enlarged and downturned maxillary flange, which has been noted before in species descriptions (see Bannikov 1992, 1993a, Fierstine 2006). Another remarkable palaeorhynchid synapomorphy is the continuous soft dorsal fin, which can be divided into two sections: an anterior one of longer ceratotrichia and a posterior one of shorter, more tightly packed rays. Where the rays are poorly preserved, one can discern the sections by the pterygiophores of the fin. In the anterior section, each ray is borne by a fan-shaped pterygiophore that possesses three radiating ridges: one extending along the trunk margin and two protruding proximally (see Fig. 38a). The pterygiophores of the caudal section appear to be simple wedge-like structures tapered away from the axial skeleton (Fig. 38b; see also Woodward 1901; Bannikov 1992, 1993a). Except for the most anterior and most posterior vertebrae, the neural and haemal spines bear a caudal ovoid-shaped plate.

Genus † *Palaeorhynchus* de Blainville, 1818

Type species. †*Palaeorhynchum glarisianum* de Blainville, 1818, p. 314, by monotypy.

Diagnosis. Upper and lower jaw of approximately equal length. Vertebrae, except for a few in the caudal peduncle,

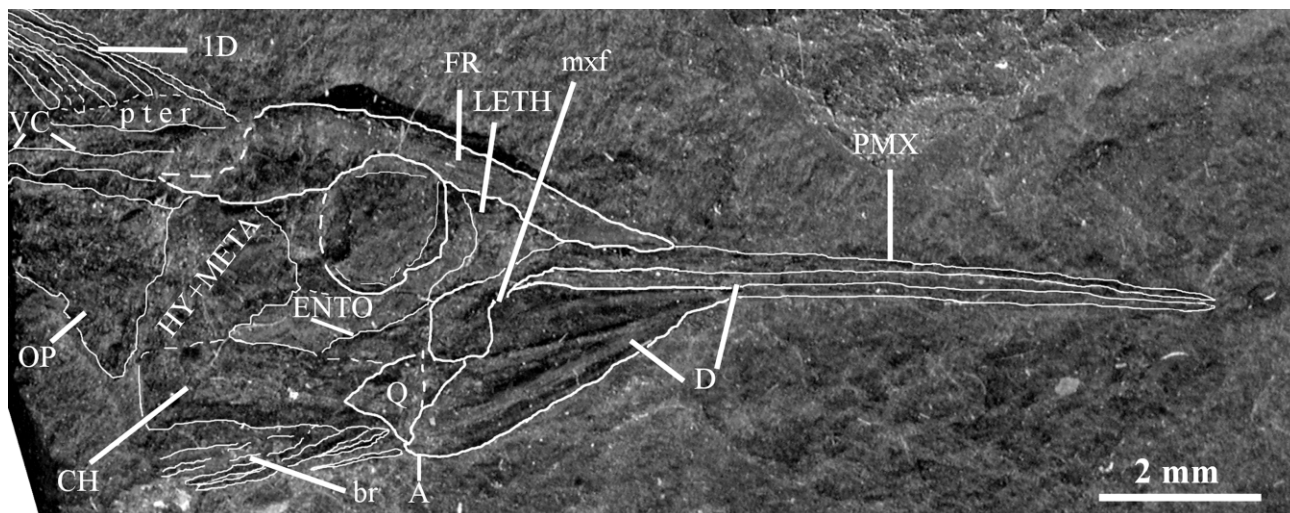

Figure 39 †*Palaeorhynchus senectus*, holotype (with interpretative clarifying tracing marks), PIN 1413/80, Tbilisi, Georgia; Lutetian? Abbreviations: ID=first dorsal fin; A=angular; br=branchiostegal rays; CH=ceratohyal; D=dentary; ENTO=entopterygoid; FR=frontal; HY=hyomandibular; LETH=lateral ethmoid; META=metapterygoid; mx=mxillary flange; OP=operculum; PMX=premaxilla; pter=pterygiophores; Q=quadrate; VC=vertebral column.

elongated and medially constricted, and thus similar to those of Recent billfish such as *Tetrapturus* Rafinesque-Schmaltz, 1810. Vertebrae of caudal peduncle somewhat shortened. Neural and haemal spines associated with pterygiophores of posterior section of dorsal and anal fin respectively, lamellar and trapezium-shaped with narrow side originating from centrum. Ceratotrichia of dorsal and anal fin relatively long (longer than maximum body depth). Pelvic fin proportionally longer than in other xiphioids, where it is twice as short as distance between its base and origin of anal fin.

Other distinguishing characters. Upper and lower jaws almost straight, not curved at tips. 53–61 (?62) vertebrae. Anterior dorsal-fin elements about as numerous as vertebrae. Scales large.

Remarks. Contrary to other scombroids, the plesiomorphic condition in Xiphoidea seems to be numerous vertebrae, with an evolutionary trend of reduction (Monsch 2000b). This is because Recent xiphioids have few (24–26) vertebrae. Only fossil forms have many more. †*Hemingwaya* has 39 vertebrae (see below). Among fossil genera, only †*Blochius* has as few vertebrae (24) as a Recent billfish (Fierstine & Monsch 2002).

†*Palaeorhynchus senectus* Danil'tshenko, 1962
(Fig. 39)

- 1962 †*Palaeorhynchus senectus* Danil'chenko, p. 123, fig. 11.
1980 †*Palaeorhynchus senectus* Dan. Danil'chenko, p. 162.
1997 †*Palaeorhynchus senectus* Dan. Bannikov & Parin, p. 135 (name only).
2000b †*Palaeorhynchini* gen. et sp. indet. Monsch, p. 157, fig. 7.63.
2010 †*Palaeorhynchus senectus* Dan. Bannikov, p. 148, text-fig. 79.

Holotype. PIN 1413/80 (Fig. 39).

Type locality. Tbilisi, Georgia; middle Eocene (Lutetian?, Dabakhana Svita).

Diagnosis. Deep head: depth equal to 31% of length.

Hypodigm. Five specimens from the type locality.

Description. Preorbital distance 61–62% of head length. More details in Danil'chenko (1962).

Remarks. The teeth in the figure of Danil'chenko (1962, fig. 11) are larger than in other billfish. Because of this, one

could suppose this to be a juvenile individual of an unidentifiable palaeorhynchid. The size of the teeth in that figure is however exaggerated; on the actual specimens (Fig. 39) they are hardly visible. The anterior process in the neural and haemal spine seems bifurcated in some places. It is neither clear whether this condition persists throughout the whole vertebral column, nor (due to the preservation of most palaeorhynchid specimens) whether this trait is found in other species.

†*Palaeorhynchus parini* Bannikov, 1992
(Fig. 40)

- 1992 †*Palaeorhynchus parini* Bannikov, p. 28, figs. 1–3 (translation: Bannikov, 1993a, p. 51).
1997 †*Palaeorhynchus parini* Ban. Bannikov & Parin, p. 135 (name only).
2000b †*Palaeorhynchus parini* Ban. Monsch, p. 156, fig. 7.61.
2002 †*Palaeorhynchus parini* Ban. Fierstine & Monsch, p. 128 (name only).
2010 †*Palaeorhynchus parini* Ban. Bannikov, p. 148, pl. XXVI, fig. 1, text-fig. 80.

Holotype. PIN 4425/13.

Type locality. Left bank of the river Pshekha, 1 km upstream of Gorny Luch village, N Caucasus, Russia; middle Eocene (Bartonian, Kuma Horizon).

Diagnosis. 58–60 vertebrae, of which 35–37 caudal. Dorsal fin with 50 (–51?) + 17 rays and anal fin with 30 + 28 rays.

Other distinguishing characters. Body elongated: maximum depth fits 11–13 times into standard length. Head depth 21–25% of its length. Anal fin originating under third or fourth before last precaudal vertebra. Nine anal pterygiophores anterior to first haemal spine.

Hypodigm. Twenty-six specimens from the type locality in PIN.

Description. Detailed description in Bannikov (1993a). Preorbital distance 65–69% of head length. Caudal fin fork-shaped rather than semilunate, despite enlarged and widely spaced median lepidotrichia. In largest specimens, neural and haemal spines become more expanded rostro-caudad than in smaller ones, resembling those of istiophorids and †*Hemingwaya* (see below).

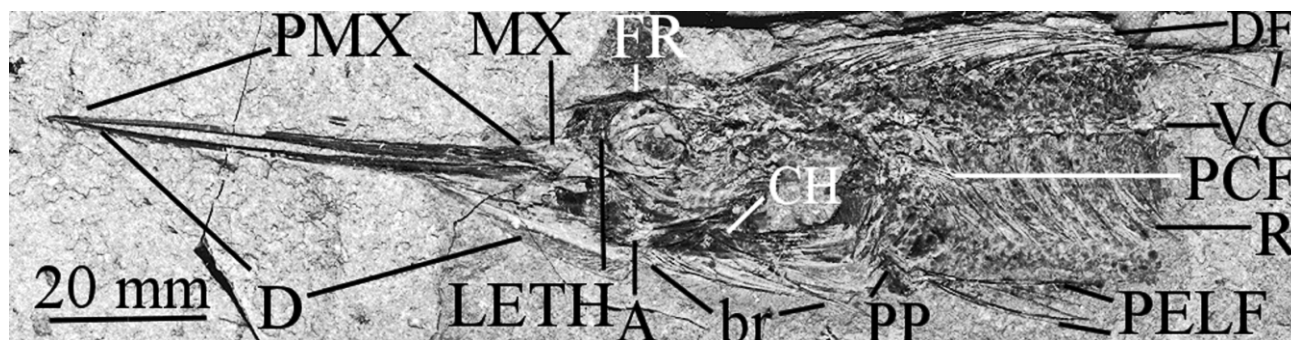

Figure 40 †*Palaeorhynchus parini*, PIN 4425/89, anterior portion of skeleton, left bank of the river Pshekha, near Gorny Luch village, N Caucasus, Russia; Bartonian. Abbreviations: A=angular; br=branchiostegal rays; CH=ceratohyal; D=dentary; DF=(continuous) dorsal fin; FR=frontal; LETH=lateral ethmoid; MX=maxilla; PCF=pectoral fin; PELF=pelvic fin; PMX=premaxilla; PP=pelvic plate; R=rib; VC=vertebral column.

†*Palaeorhynchus zitteli* (Kramberger, 1879)
(Fig. 41)

- 1879 †*Hemirhynchus zitteli* Kramberger, p. 59, pl. 15, fig. 1.
1886 †*Palaeorhynchus zitteli* (Kramb.) Wettstein, p. 72.
1888 †*Palaeorhynchus zitteli* (Kramb.) von Zittel, p. 301, fig. 312.
1901 †*Palaeorhynchus zitteli* (Kramb.) Woodward, 1901, p. 487.
1909 †*Hemirhynchus zitteli* Kramb. Rychlicki, p. 755.
1923 †*Palaeorhynchus zitteli* (Kramb.) Broili & Schlosser, p. 148, fig. 255.
1929c †*Palaeorhynchus* cf. *zitteli* (Kramb.) Paucă, p. 209.
1934 †*Palaeorhynchus* cf. *zitteli* (Kramb.) Paucă, p. 617, pl. 3, fig. 4, text-fig. 18.
1960 †*Palaeorhynchus zitteli* (Kramb.) Danil'chenko, p. 159, pl. 15, fig. 1.
1965 †*Palaeorhynchus zitteli* (Kramb.) Temnyuk, p. 1077 (figure only).
1987 †*Palaeorhynchus zitteli* (Kramb.) Schultz, fig. 5, tab. 3 (name only).
1997 †*Palaeorhynchus zitteli* (Kramb.) Bannikov & Parin, p. 138 (name only).
2000b †*Palaeorhynchini* gen. et sp. indet. Monsch, p. 158.
2010 †*Palaeorhynchus zitteli* (Kramb.) Bannikov, p. 148, pl. XXV, fig. 4.

Lectotype. A specimen in BSP (not seen).

Type locality. Rajcza, Polish Galicia; lower Oligocene (Rupelian).

Diagnosis. Maximum body depth 11–12 times into standard length. Anal fin originating under 5–7th before last precaudal vertebra. Up to 15 anal pterygiophores anterior of first haemal spine.

Other distinguishing characters. 58–61 (?62) vertebrae, of which 33–35 caudal. Head shallow: depth 23–26% of length. Pelvic fin with about five lepidotrichia.

Hypodigm. PIN contains 43 specimens from the river Belaya (N Caucasus), five from the river Gumista (Abkhazia) and one from the Ukrainian Carpathians (Rupelian). Besides these and the holotype, the total hypodigm is difficult to assess. Specimens are recorded from the Polish part of Galicia and Romania (Schultz 1987; Bannikov 1993a).

Description. Preorbital distance is 64–68% head length. A well-accessible description of former USSR specimens is in Danil'chenko (1967).

Genus †*Homorhynchus* van Beneden, 1873

Type species. †*Homorhynchus bruxelliensis* van Beneden, 1873, p. 207, by monotypy.

Diagnosis. Lower jaw not elongated, much shorter than rostrum. Two pterygiophores interneural spaces in anterior part of dorsal fin. Ceratotrichia of dorsal and anal fin relatively short (shorter than maximum body depth). Pelvic fin with two lepidotrichia.

Other distinguishing characters. 53–55 (25–26+28–29) vertebrae. Pelvic fin short.

†*Homorhynchus colei* (Agassiz, 1844)
(Fig. 42)

- ?1833–44 †*Palaeorhynchum egertoni* Agassiz, p. 80, pl. 34a, fig. 1.
1833–44 †*Palaeorhynchum colei* Agassiz, p. 85, pl. 32, fig. 1.
1833–44 †*Palaeorhynchum microspondylum* Agassiz, p. 85, pl. 34a, fig. 2.
1867 †*Palaeorhynchum* [sic] sp. de Glarus. Winkler, p. 632.
1886 †*Hemirhynchus colei* (Ag.) Wettstein, p. 78.
1901 †*Hemirhynchus colei* (Ag.) Woodward, p. 488.
1958 †*Hemirhynchus colei* Ag. van Regteren Altena, p. 370, fig. 1.
1960 †*Homorhynchus colei* (Ag.) Danil'chenko, p. 161, pl. 15, fig. 2.
1964 †*Homorhynchus colei* (Ag.) Danil'chenko, pl. 9, fig. 2.
non1977 †*Palaeorhynchus longirostris* Ag. Ciobanu, 1977, p. 121, pl. 42, fig. 1.
1980 †*Homorhynchus colei* (Ag.) Danil'chenko, p. 164, pl. 6, fig. 3.
1987 †*Homorhynchus colei* (Ag.) Schultz, p. 118 (name only).
1997 †*Homorhynchus colei* (Ag.) Bannikov & Parin, p. 138 (name only).
2000b †*Homorhynchus colei* Ag. Monsch, p. 153, fig. 7.59.
2002 †*Homorhynchus colei* (Ag.) Fierstine & Monsch, p. 128 (name only).
2010 †*Homorhynchus colei* (Ag.) Bannikov, p. 149, pl. XXVI, fig. 2.

Lectotype. BMNH P4122.

Type locality. Engi, Canton Glarus, Switzerland; lower Oligocene (Rupelian, Glarner Schiefers).

Diagnosis. As for genus (despite that two other species are known from older sediments, †*H. colei* seems to be morphologically more primitive than those).

Other distinguishing characters. Skull shallow: depth about two thirds of maximum body depth (Woodward 1901). 54–55 (26+28–29) vertebrae (25+28 in Danil'chenko 1960).

Hypodigm. The total hypodigm is difficult to assess. Here follows an overview of what is known. TM has one (Van Regteren Altena 1958) and BMNH seven (Woodward 1901) specimens from the type locality; MSNPN has one specimen (Ciobanu 1977) from the Rupelian of Piatra Neamț, Romania.

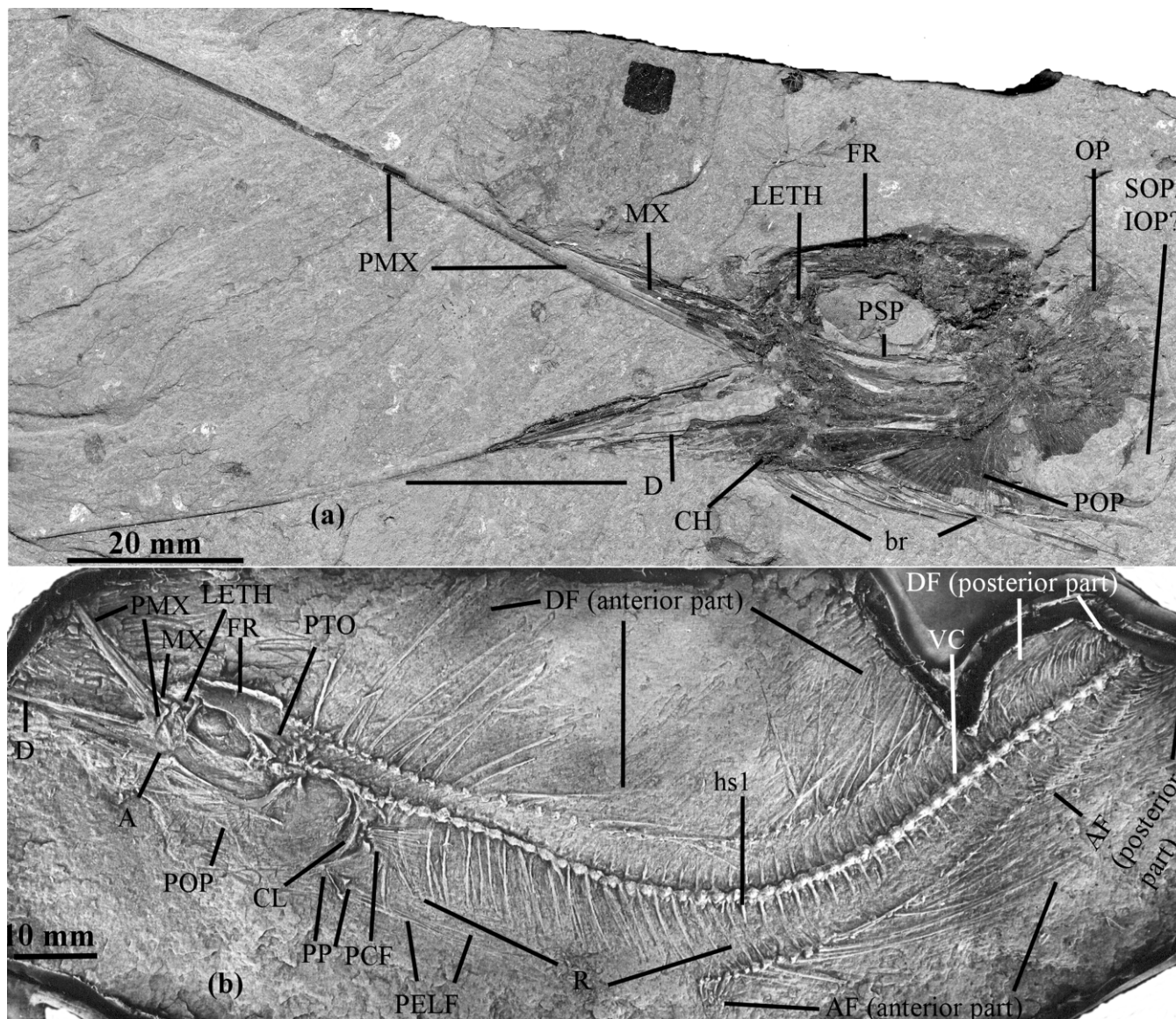

Figure 41 †*Palaeorhynchus zittelli*, River Belaya, N Caucasus, Russia; Rupelian: (a) PIN 3363/177 (transfer-prepared); (b) PIN 1413/49. Abbreviations: A=angular; AF=anal fin; br=branchiostegal rays; CH=ceratohyal; CL=cleithrum; D=dentary; DF=(continuous) dorsal fin; FR=frontal; hsl=first haemal spine; IOP=interoperculum; LETH=lateral ethmoid; MX=maxilla; OP=operculum; PCF=pectoral fin; PELF=pelvic fin; PMX=premaxilla; POP=preoperculum; PP=pelvic plate; PSP=parasphenoid; PTO=pteroitic; R=ribs; SOP=suboperculum; VC=vertebral column.

The specimens of the former USSR in PIN are from the Rupelian (Pshekha Horizon): 36 from the river Belaya and two from the river Pshekha, N Caucasus, Russia; and one from the river Gumista in Abkhazia.

Description. A detailed description was given by Danil'chenko (1967). Additional information and/or corrections to that description are given below. Lachrymal shorter than diameter of orbit. Hypurostegic caudal fin with widened and more widely spaced medial lepidotrichia (despite this, caudal fin forked rather than semilunate) and a total of 31 lepidotrichia (including 17 principal rays). Dorsal fin with 101–108 rays, of which posterior section covers ca. 20 rays. Of the 57–59 (32–33+25–26) rays of the anal fin, about five are anterior of first haemal spine.

Genus †*Pseudotetrapturus* Danil'tshenko, 1960

Type species. †*Pseudotetrapturus luteus* Danil'tshenko, 1960, p. 162, by monotypy and original designation.

Diagnosis. Lower jaw elongated, almost as long as upper; both jaws curved at tips. Dorsal fin originating above posterior border of orbit and is deeper than body. Pelvic fin with four lepidotrichia, without spine.

Other distinguishing characters. 45–50 vertebrae, scales large (Danil'chenko, 1960).

Remarks. Bannikov (2010) proposed that the upper Oligocene †*Aglyptorhynchus maxillaris* Fierstine, 2001 from Oregon (USA) may belong to †*Pseudotetrapturus*.

†*Pseudotetrapturus luteus* Danil'tshenko, 1960
(Fig. 43)

1960 †*Pseudotetrapturus luteus* Danil'chenko, p. 162, pl. 23, figs. 1, 2.

1964 †*Pseudotetrapturus luteus* Danil'chenko, pl. 9, fig. 1.

1980 †*Pseudotetrapturus luteus* Dan. Danil'chenko, p. 164, pl. 7, fig. 3.

1987 †*Pseudotetrapturus luteus* Dan. Schultz, p. 132, figs. 3, 5.

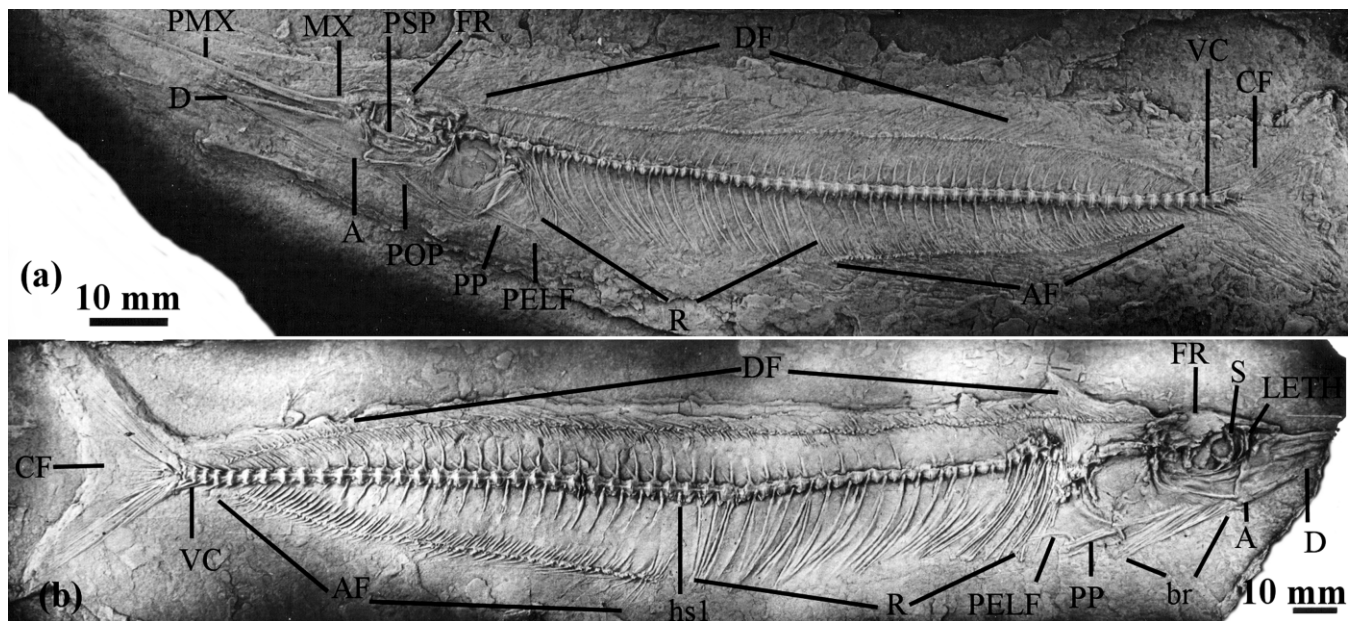

Figure 42 †*Homorhynchus colei*, River Belaya, N Caucasus, Russia; Rupelian, transfer prepared: (a) PIN 3363/135; (b) PIN 3363/134. Abbreviations: A=angular; AF=anal fin; br=branchiostegal rays; CF=caudal fin; D=dentary; DF=dorsal fin; FR=frontal; hs1=first haemal spine; LETH=lateral ethmoid; MX=maxilla; PELF=pelvic fin; PMX=premaxilla; POP=preoperculum; PP=pelvic plate; PSP=parasphenoid; R=ribs; S=sclerotic; VC=vertebral column.

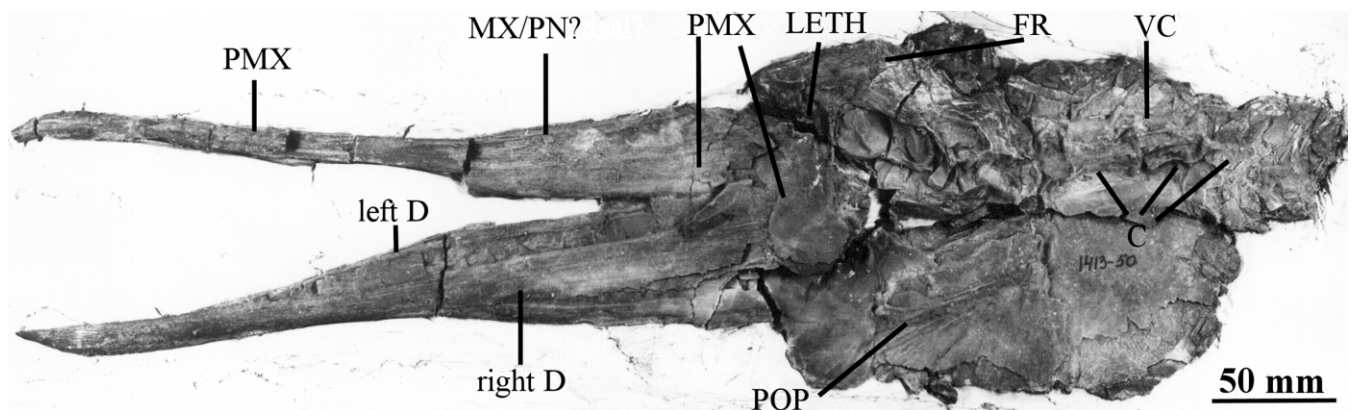

Figure 43 †*Pseudotetrapturus luteus*, holotype, PIN 1413/50, River Sulak, NE Caucasus, Russia; Chattian. Abbreviations: C=centrum; D=dentary; FR=frontal; LETH=lateral ethmoid; MX=maxilla; PN=prenasal; POP=preoperculum; VC=vertebral column.

- 1993 †*Pseudotetrapturus luteus* Dan. Patterson, p. 634 (name only).
 1997 †*Pseudotetrapturus luteus* Dan. Bannikov & Parin, p. 138 (name only).
 2000b †*Pseudotetrapturus luteus* Dan. Monsch, p. 156, fig. 7.62.
 2002 †*Pseudotetrapturus luteus* Dan. Fierstine & Monsch, p. 128 (name only).
 2010 †*Pseudotetrapturus luteus* Dan. Bannikov, p. 150, pl. XXVI, fig. 3.

Holotype. PIN 1413/50 (Fig. 43).

Type locality. River Sulak, Daghestan, N Caucasus, Russia; upper Oligocene (Chattian, Maykop series).

Diagnosis and other distinguishing characters. As for genus.

Hypodigm. Two specimens from the type locality and one from the Chattian of the river Gumista, Abkhazia.

Description. Detailed description by Danil'chenko (1960), who reported that neurapophyses have flattened processes. This means that neural (and, as can be observed haemal) spines have enlarged plate-like extensions. This is a synapomorphy of Palaeorhynchidae (see Fig. 38a). The following

additional observations regarding the rostrum have been made. Bill is deeper than wide in cross-section, its dorsal surface arched with shallow longitudinal grooves. Ventral surface rather flat. Anterior part of rostrum with two lateral patches of small villiform teeth. Unclear whether these two patches fuse caudad into one, stay separate or disappear. At least one central canal present, but other details of internal anatomy obscured. Abkhazian specimen in public exhibition of PIN with pelvic plate on which remains of pelvic fin preserved.

Remarks. Danil'chenko's (1960) observations about the total length (4 m) of the holotype, its squamation and vertebral count are from his field notes. The holotype was a fairly complete specimen, which was unfortunately heavily damaged by robbers who invaded the area of fieldwork (P. G. Danil'chenko pers. comm. 1979).

Family †Hemingwayidae Sytchevskaya & Prokofiev, 2002
 Genus †*Hemingwaya* Sytchevskaya & Prokofiev, 2002

Type species. †*Hemingwaya sarissa* Sytchevskaya & Prokofiev, 2002, p. 229, by monotypy and original designation.

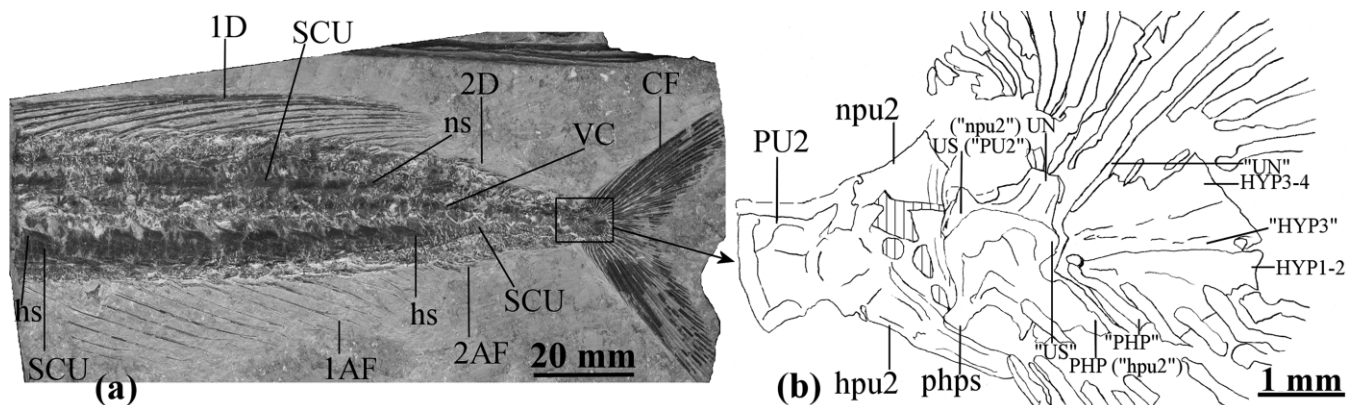

Figure 44 †*Hemingwaya sarissa*, holotype, PIN 4782/81, Uilya Kushlyuk, Turkmenistan; Thanetian: (a) photo of holotype; (b) line drawing of caudal skeleton. Prokofiev's (2004) later reconstruction of the tail region corresponds more to our findings, although not entirely (see text for details). Abbreviations: 1AF=first anal fin; 2AF=second anal fin; 1D=first dorsal fin; 2D=second dorsal fin; CF=caudal fin; hpu2=haemal spine of second preural vertebra; hs=haemal spine; HYP=hypural; npu2=neural spine of second preural vertebra; ns=neural spine; PHP=parhypural; phps=parhypurapophysis; PU2=second preural vertebra; UN=uroneural; US=urostyle; SCU=scute; VC=vertebral column. Plain labels indicate how we identify these elements; those in quotation marks indicate how Sytchevskaya and Prokofiev (2002) identified elements, in cases where their and our interpretations differ.

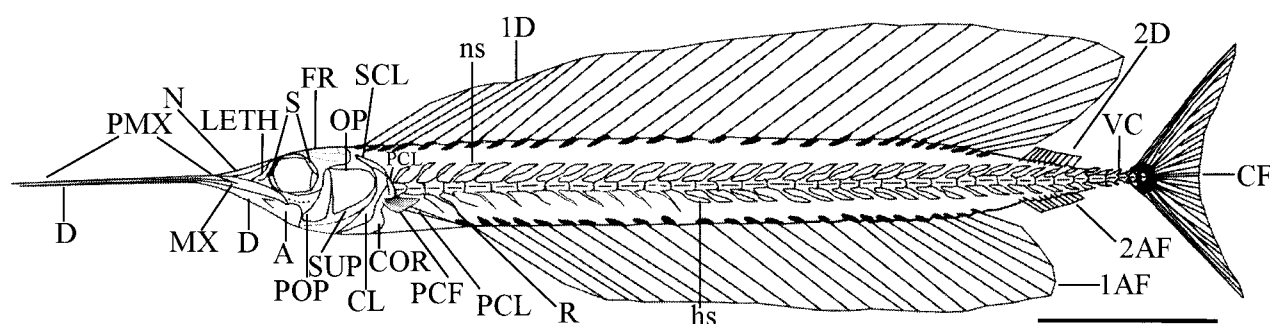

Figure 45 †*Hemingwaya sarissa*, Uilya Kushlyuk, Turkmenistan; Thanetian. Reconstruction, based on Firerstone's (2006) drawing from his review of fossil billfish, with added lettering and a corrected amount of ribs, scale approximates 50 mm. Abbreviations: 1AF=first anal fin; 2AF=second anal fin; 1D=first dorsal fin; 2D=second dorsal fin; A=angular; CF=caudal fin; CL=cleithrum; COR=coracoid; D=dentary; FR=frontal; hs=haemal spine; LETH=lateral ethmoid; MX=maxilla; N=nasal; ns=neural spine; OP=operculum; PCF=pectoral fin; PCL=postcleithrum; PMX=premaxilla; POP=preoperculum; R=rib; S=sclerotics; SCL=supracleithrum; SUP=suboperculum; VC=vertebral column.

Diagnosis. The lower jaw elongated, about as long as rostrum. Skull roof ornamented with crests and pits. Pelfic fin absent. Two dorsal and two anal fins. First dorsal with about 32, first anal with about 26 lepidotrichia. About 39 (16+23?) vertebrae. Neural and haemal spine widened and leaf-shaped. Postorbital section of head and body covered with six longitudinal rows of thick, mostly hexagonal, scutes.

Other distinguishing characters. Jaws with multiple rows of small villiform teeth. Caudal skeleton primitive for xiphioid: built as in Scombrini.

Remarks. The phylogenetic hypothesis of Sytchevskaya & Prokofiev (2002), that Hemingwayidae and Istiophoridae form a monophyletic clade, based on the remarkable synapomorphy of foliarly shaped neural and haemal spines, seems best for now.

†*Hemingwaya sarissa* Sytchevskaya & Prokofiev, 2002
(Figs 44, 45)

2002 †*Hemingwaya sarissa* Sytchevskaya & Prokofiev, p. 229, figs. 1–4.

2004 †*Hemingwaya sarissa* Sytch. & Prok. Prokofiev, p. 125, figs. 1–2.

2010 †*Hemingwaya sarissa* Sytch. & Prok. Bannikov, p. 152, pl. XXVI, fig. 4.

Holotype. PIN 4782/81 (Fig. 44a, b).

Type locality. Near Uilya-Kushlyuk, Turkmenistan; upper Palaeocene (Thanetian, Danata Svita).

Diagnosis and other distinguishing characters. As for genus.

Hypodigm. Thirteen skeletal fragments from the type locality in PIN.

Description. The original description (Sytchevskaya & Prokofiev 2002) differs so much from our own observations, that, contrary to the treatment of other species in this paper, we provide a detailed description. Except where indicated otherwise, current observations agree with either the original description of Prokofiev (2004), who in part revises Sytchevskaya & Prokofiev (2002). Prokofiev's (2004) paper came after personal communications between us and Sytchevskaya and Prokofiev about †*Hemingwaya* in 2003. Prokofiev's (2004) re-interpretations still differ from our observations.

It is not known how Sytchevskaya & Prokofiev did age estimation (apparently by using vertebrae). Age supposedly "... varies within four-six years" according to Sytchevskaya & Prokofiev (2002, p. 228). Bony structure of fossils, however, confirms specimens as fully developed individuals. Fork length estimated at 0.3–0.4 m. Body elongated and shallow (Fig. 45); head length without rostrum 1.25 times greater than maximum body depth. Trunk relatively abruptly tapering caudad at caudal peduncle. Both lower and upper jaws elongated, about

equal in length (lower jaw slightly shorter), robust proximally, gradually tapering and sharp-pointed. Jaws about twice as long as distance from anterior margin of orbit to posterior margin of opercular apparatus. Both upper and lower jaws with multiple rows of small villiform teeth. Rostrum consisting of maxilla, premaxilla and nasal. Presence or absence of prenasal uncertain. Orbit bordered anteriorly by lateral ethmoid (interpreted by Sytchevskaya & Prokofiev 2002 as lachrymal). Frontal ornamented by series of low longitudinal crests and minute pits (also found on parietal). Supraoccipital crest hardly developed. Prerotic spine seemingly short. Except for suboperculum, opercular apparatus well preserved, similar to that of istiophorids. Gill arches partially discernible, but presence of gill rakers uncertain. Number of branchiotegeal rays uncertain. Sytchevskaya & Prokofiev state that there are probably seven, but we have been unable to estimate even a minimum count. Posttemporal not preserved, besides that, the pectoral girdle almost completely intact, similar to that of scombrids (see e.g. Collette & Russo 1985). Small pectoral fin with about 15 lepidotrichia. Pelvic plate and fin absent. Vertebrae moderately long, shortened in caudal peduncle and medially slightly constricted. Massive prezygapophyses, but postzygapophyses not seen – may be undeveloped. First few vertebrae in precaudal section of vertebral column and those of the caudal peduncle with slightly expanded, lancet-like neural and haemal spine. Remaining vertebrae with further modified vertebral spines: strongly expanded, lamellar and leaf-shaped, abruptly tapering dorso-posteriad, similar to neural; and haemal spine in istiophorids and largest specimens of palaeorhynchids (†*Palaeorhynchus parini* and †*Pseudotetrapturus luteus*). Total number of vertebrae uncertain, but we estimate 39 (about 40 cf. Sytchevskaya & Prokofiev 2002, who interpret urostyle as urostyle and preural vertebra 1 fused together, see below). No less than 16 vertebrae are precaudal (estimated through observation of poorly-visible ribs, the posteriormost of which is associated with the 16th vertebra in PIN 4782/89). Prokofiev (2004) asserted that the most posterior rib is between the 15th and 20th vertebrae. Lateral crests on preural vertebrae, noticed by Prokofiev (2004), not found. Caudal skeleton consisting of two hypural plates formed by fusion of hypurals 1–2 and 3–4 respectively, and autogenous, long urostyle (a trait of billfish) with massive uroneural fused to it. Large free parhypural present, in which parhypurapophysis damaged (Fig. 44b). According to Prokofiev (2004), parhypural fused to urostyle. Hypurals 1–2 and 3–4 completely fused within the small plates, only shallow grooves present where Prokofiev (2004) observes sutures between supposedly not completely fused hypurals 1–2 and 3–4 respectively (Fig. 44b). Rod-like element, interpreted by Prokofiev & Sytchevskaya (2002) as narrow third hypural not found. Shallow groove is present in place of rod (Fig. 44b). Prokofiev (2004) considers ‘rod’ a split-off part of a larger hypural 3. Hypural 5 not found (this region obscured by hypurostegic caudal-fin rays in holotype). Unclear whether it developed, is missing, or fused to hypurals 3–4. ‘Urostyle process’ of Prokofiev (2004) refers to the uroneural. Prokofiev’s (2004) ‘hypural crest’ (Sytchevskaya & Prokofiev’s, 2002 uroneural), is an extended base of a caudal-fin ray (Fig. 44b). Articulation of caudal skeleton with preceding preural vertebra normal, anterior margin of the hypural complex not convex and hinged on an extremely shortened free urostyle that is fused to the first preural vertebra (really urostyle and parhypural together) (Sytchevskaya & Prokofiev 2002). Bases of caudal-fin rays cover much of hypurals and obscure epurals. Caudal fin large and forked with 33 slightly widened median lepidotrichia, of which 17 procurrent. Two distinct dorsal fins and two distinct anal fins, as in Recent billfish, unlike †*Palaeorhynchus* (with both dorsal and

anal fins are continuous and divided in two sections). First pterygiophore of first dorsal fin inserted in preneural space, above orbit. First complete dorsal-fin ray visible behind orbit, meaning, at border of skull and first vertebra. First dorsal fin extending caudad to border between eighth and ninth preural vertebra, which would be between 31st and 32nd vertebra counted from anterior. For both first dorsal and anal fin, seemingly one pterygiophore inserted near each border between two vertebrae. Based on the above, first dorsal fin with estimated 32 rays (possibly more). First ray of first anal fin inserted below seventh vertebra, almost immediately followed by second anal-fin ray, at the border between 7th and 8th vertebra. Each following pterygiophore inserted at border between subsequent vertebrae. First anal fin extending caudad to border between the 31st and 32nd vertebra. From this, estimated 26 first anal-fin rays. Both first dorsal and anal fins deep. Dorsal-fin rays 1.2 (Most anterior) – 2.5 (towards caudalmost end of fin) times longer than maximum body depth. Anal fin with similar shape, but longest ray (towards caudalmost end) only 1.5 times longer than maximum body depth. Both second dorsal and anal fins are much shallower and shorter than first dorsal and anal fins. Rays are closer together, but preservation of this region in specimens available insufficient to count them. Both second dorsal and anal fins reaching up to beginning of caudal peduncle.

Body covered by thick, large (most of them 1 mm in diameter) scutes rather than scales (Fig. 44a). Most of these more or less hexagonal, but on caudal peduncle becoming square. Scutes relatively deep: six longitudinal rows seemingly covering entire side of body.

Remarks. Sytchevskaya & Prokofiev (2002) interpret the lateral ethmoid as the lachrymal, based on presence of branched canals. However, branched canals are not found by us, only a few exterior foramina characteristic for lateral ethmoids. Sytchevskaya & Prokofiev suppose that in billfishes the lachrymal completely covers the lateral ethmoid, stating that in Gregory & Conrad (1937) the lateral ethmoid and lachrymal were mixed up. However, Gregory & Conrad (1937, fig. 7), picturing a skull of *Scomber* with a lachrymal and lateral ethmoid (‘parethmoid’) correctly indicated, proved their insight is correct. The lachrymal is one of the circumorbital (or suborbital) bones. These do occur in Recent xiphioids and were separately mentioned by Gregory & Conrad (1937), although not included in their figures of billfish skulls (see also Nakamura 1983, 1985 on billfish lachrymals). Sytchevskaya & Prokofiev (2002) compare †*Hemingwaya* to †*Homorhynchus*, in which they also wrongly consider its lateral ethmoid to be a lachrymal. While Sytchevskaya & Prokofiev asserted that †*Blochius* also possesses a lachrymal, Fierstine & Monsch (2002) showed that in this genus this is a relatively small bone that laterally flanks the lateral ethmoid, partially covering it. Real lachrymals (probably small, fragile bones that were damaged in the process of fossilisation) are not preserved in specimens of †*H. sarissa*. Sytchevskaya & Prokofiev (2002) mistakenly took the point of insertion of the first anal fin (at the 7th vertebra) as the start of the caudal section of the backbone, thus claiming that this fish had a very short precaudal vertebral column, implying too little space for internal organs. In Recent as well as in fossil billfish (see also †*Palaeorhynchidae* as described herein) the anal fin is inserted quite some distance anterior to the first caudal vertebra. That the first anal fin is inserted this much anterior of the first caudal vertebra is, however, a remarkable apomorphy of †*Hemingwaya* (also noted by Prokofiev 2004). Sytchevskaya & Prokofiev (2002) described an unusual morphology of the transition between the last vertebra and the hypural complex.

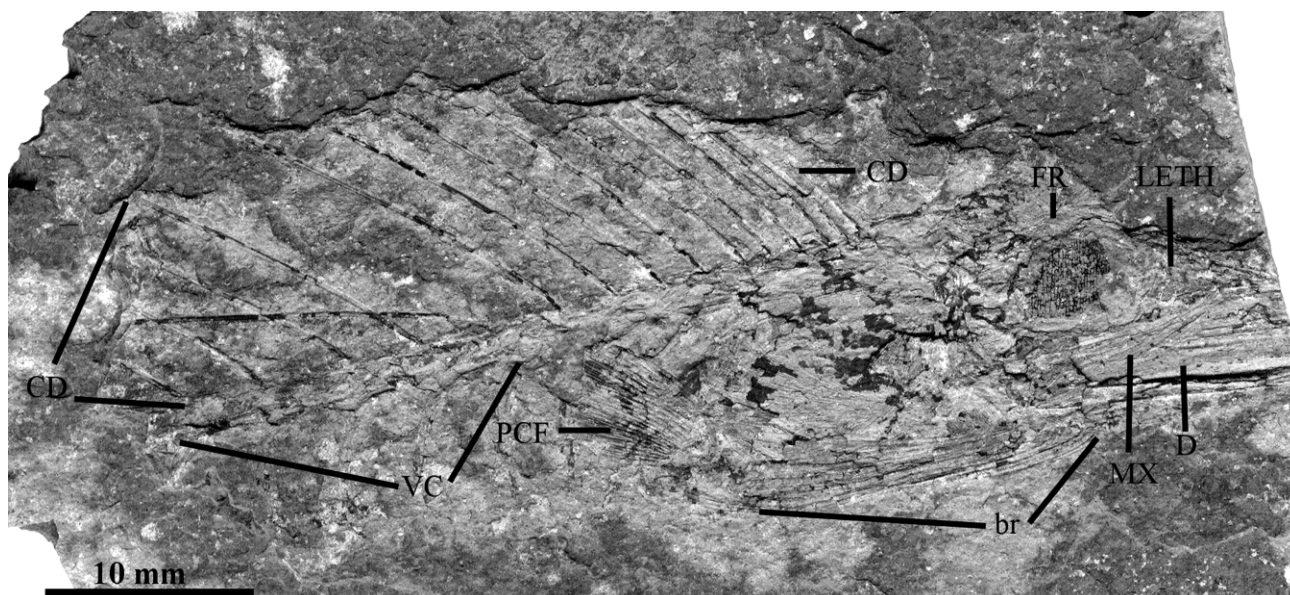

Figure 46 †*Blochiidae incertae sedis* sp., PIN 1762/116, Uilya Kushlyuk, Turkmenistan; Thanetian. Abbreviations: br=branchiostegal rays; CD=continuous dorsal fin; D=dentary; FR=frontal; LETH=lateral ethmoid; MX=maxilla; PCF=pectoral fin; VC=vertebral column.

Such a connection does not occur in any known fish. Normally, the hypural complex articulates loosely with the preceding vertebra, with a cartilaginous connection between the two. There are no grounds for assuming the presence of a hinge joint (extensively discussed by Sytchevskaya & Prokofiev) inside the caudal skeleton of †*Hemingwaya*, which is built quite in the same manner as in the scombrine scombrids. Even though the hinge joint was not mentioned in a later paper on this species, a reconstruction of the caudal skeleton therein (Prokofiev 2004, fig. 2) suggested that the author supposed such a joint to be present.

Family †*Blochiidae*? Bleeker, 1859
 †*Incertae sedis* sp.
 (Fig. 46)

- 1993d †*Blochiidae* gen. et sp. indet. Bannikov, p. 242 (name only).
 1997 †*Blochiidae* (?) gen. et sp. indet. Bannikov & Parin, p. 134 (name only).
 2002 †*Blochiidae* indet. Sytchevskaya & Prokofiev, p. 227 (name only).

Diagnosis. Rostrum present, vertebral column and dorsal fin very close to one another.

Material. One specimen from Uilya-Kushlyuk, Turkmenistan; upper Palaeocene (Thanetian, Danata Svita), in PIN.

Description. Poorly preserved fragment of individual about 40 mm in total length. Anterior part of rostrum not preserved. Number of branchiostegal rays difficult to assess, but there are certainly six. Vertebral column preserved until 10th vertebra. Vertebrae medially constricted, hourglass-shaped, more than four times longer than deep. First 15 dorsal-fin spines preserved, longest clearly deeper than head depth. Pterygiophores and neural spines hardly visible. Pectoral fin with 22 lepidotrichia.

Remarks. The specimen is too poorly preserved for a detailed analysis and description. Fierstine & Monsch (2002) showed that in †*Blochius* Volta, 1796, the dorsal fin is close to the vertebral column because of the short neural spines and pterygiophores. The †*Blochiidae* as they are often understood (Schultz 1987), comprise a few genera, of which now only

†*Blochius* is accepted as belonging to the family (Fierstine & Monsch 2002; Fierstine 2006). While †*Blochiidae sensu* Schultz (1987) originate in the Cretaceous, †*Blochius* is restricted to the Monte Bolca locality (basal Lutetian, following Aubry's (1983) dating of the NP14 zone, or terminal Ypresian following Papazzoni & Trevisani (2006)) of Italy. The fossil specimen under consideration would stretch the fossil record of blochiids considerably back in time.

3. Acknowledgements

Much of the contribution of KAM was part of his PhD project 'The Phylogeny of the Scombroid Fishes' carried out at the University of Bristol and supervised by M. J. Benton, Bristol, and P. L. Forey, BMNH, as well as of research carried out during tenure at the Institute of Zoology of the University of Wrocław, Poland. KAM received financial support from: the Department of Earth Sciences, Bristol; EU funding organisations (LSF, COLPARSYST); a Short-Term Visitor's Grant of USNM; 'Badania Własne' grants (2020/W/IZ/) of the University of Wrocław; and a Bonhote, Omer-Cooper and Westwood Fund (Linnaean Society of London); and acknowledges B. B. Collette, J. C. Tyler (both of USNM), O. Crimmen (BMNH) and D. Goujet (MNHN) for access to museum collections, assistance and hospitality, and the Monsch family in the Netherlands for their support of the PhD project. Five grants of the National Geographic Society (USA) (for 1993, 1999, 2001, 2003, 2007) supported the field excavations of AFB in N Caucasus. Research of AFB was also supported by the Russian Foundation for Basic Research, grant no. 09-05-00170. E. K. Sytchevskaya (PIN) kindly allowed access to the type material of †*Hemingwaya sarissa*. Most of the photographs were taken by A. V. Mazin at PIN. The comments of Giorgio Carnevale, Harry Fierstine and an anonymous reviewer greatly improved the quality of this paper, as did the thorough editorial revisions of M. J. Benton. We also thank the Royal Society of Edinburgh's Journals Officer, Mrs V. M. Hammond for her patience.

4. References

- Agassiz, L. 1833–1844. *Recherches sur les Poissons Fossiles*. Vol. 5., Neuchâtel: Imprimerie de Petitpierre.

- Agassiz, L. 1834. Über das Alter der Glarner Schiefer-Formation, nach ihren Fisch-Resten. *Neues Jahrbuch von Mineralogie, Geologie und Paläontologie* **1834**, 301–06.
- Agassiz, L. 1835. Kritische Revision der in der Ittiolitologia Veronese abgebildeten fossilen Fische. *Neues Jahrbuch für Mineralogie, Geognosie, Geologie und Petrefaktenkunde* **3**, 290–316.
- Arambourg, C. 1925. Révision des poissons fossiles de Licata (Sicile). *Annales de Paléontologie* **14**, 39–132.
- Arambourg, C. 1927. Les poissons fossiles d'Oran. *Matériaux pour la Carte Géologique de l'Algérie, 1^{re} Série: Paléontologie* **6**, 1–298.
- Arambourg, C. 1967. Résultats scientifiques de la Mission C. Arambourg en Syrie et en Iran (1938–1939). II. Les poissons oligocènes de l'Iran. *Notes et Mémoires sur le Moyen-Orient* **6**, 9–210.
- Arratia, G. 2010. Critical analysis of the impact of fossils on teleostean phylogenies, especially that of basal teleosts. In Elliott, D. K., Maisey, J. G., Yu, X. & Miao, D. (eds) *Morphology, Phylogeny and Paleobiogeography of Fossil Fishes*, 247–74. Munich: Verlag Dr. Friedrich Pfeil.
- Aslanova, S. M. 1960. Nekotorye svedeniya ob iskopyayemoy ikhtiofaune Shemakhinskogo rayona. *Izvestiya Akademii Nauk Azerbaidzhanskoi SSR. Seriya Geologicheskaya i Geograficheskaya* **1960**, 77–84.
- Aubry, M. P. 1983. Biostratigraphie du Paléogène épicontinental de l'Europe du Nord-Ouest. Etude fondée sur les nannofossiles calcaires. *Documents du Laboratoire de Géologie de la Faculté des Sciences de Lyon* **89**, 1–320.
- Averianov, A. O., Nesov, L. A. & Udovichenko, N. I. 1993. Pozdnepaleotsenovyj kompleks kostnykh ryb i drugikh pozvonochnykh mestonakhozhdeniya Dzhilga v Yuzhnom Kazakhstane. In Tleuberdina, P. A. (ed.) *Faunisticheskiye i floristicheskiye komplekсы mezozoya i kaynozoya Kazakhstana. Materialy po istorii fauny i flory Kazakhstana* **12**, Almaty: Baspager.
- Baciu, D.-S. & Bannikov, A. F. 2004. New stromateoid fishes (Perciformes, Stromateoidei) from the Lower Oligocene of Romania. *Journal of Ichthyology* **44** (3), 199–207. [Translated from *Voprosy Ikhtiologii*.]
- Bannikov, A. F. 1978. Novyj rod skumbriyevykh iz verkhnego paleotsena Turkmenii. *Paleontologicheskii Zhurnal* **3**, 79–83. [English version in *Paleontological Journal* **12** (3)].
- Bannikov, A. F. 1979a. Skumbrievye iz oligotsena Kavkaza. *Paleontologicheskii Zhurnal* **1**, 97–103. [English version in *Paleontological Journal* **13** (1)].
- Bannikov, A. F. 1979b. Tuntsovye i ikh filogeneticheskiye ot-nosheniya. *Paleontologicheskii Zhurnal* **3**, 97–107. [English version in *Paleontological Journal* **13** (3)].
- Bannikov, A. F. 1980. Makrelevye paleogena SSSR. In: *Paleontologiya: Materialy Nauchnykh Zasedanii Sektsii Paleontologii Moskovskogo obshchestva Ispytatelei Prirody za 1977–1978 Gody*. Moscow: Nauka.
- Bannikov, A. F. 1982. A new species of mackerel from the Upper Eocene of Mangyshlak. *Paleontological Journal* **16** (2), 135–39. [Translated from *Paleontologicheskii Zhurnal*.]
- Bannikov, A. F. 1985. Iskopyayemye skumbrievye SSSR [Fossil scombrids of the USSR]. *Trudy Paleontologicheskogo Instituta Akademii Nauk SSSR* **210**, 1–111.
- Bannikov, A. F. 1992. Novyj vid roda *Palaeorhynchus* (Perciformes, Palaeorhynchidae) iz verkhnego eotsena Severnogo Kavkaza. *Voprosy Ikhtiologii* **32** (6), 27–32.
- Bannikov, A. F. 1993a. A new species of the genus *Palaeorhynchus* (Perciformes, Palaeorhynchidae) from the Upper Eocene in the Northern Caucasus. *Journal of Ichthyology* **33** (3), 50–56. [Translation of Bannikov 1992.]
- Bannikov, A. F. 1993b. A Late Eocene *Palimphytes* (Teleostei, Perciformes) from the Northern Caucasus. *Paleontological Journal* **27** (2), 95–103. [Translated from *Paleontologicheskii Zhurnal*.]
- Bannikov, A. F. 1993c. Fossil stromateoid fishes of the families Nomeidae and Ariommidae (Perciformes). *Paleontological Journal* **27** (4), 108–19. [Translated from *Paleontologicheskii Zhurnal*.]
- Bannikov, A. F. 1993d. The succession of the Tethys fish assemblages exemplified by the Eocene localities of the southern part of the former USSR. *Kaupia – Darmstädter Beiträge zur Naturgeschichte* **2**, 241–46.
- Bannikov, A. F. 2005. A new species of the snake mackerel genus *Abadzekhia* (Perciformes, Gempylidae) from the Lower Eocene of the Northern Caucasus. *Paleontological Journal* **39** (1), 65–68. [Translated from *Paleontologicheskii Zhurnal*.]
- Bannikov, A. F. 2008. A new genus and species of putative euzaphlegid fish from the Eocene of Bolca in Northern Italy (Perciformes, Trichiuroidea). *Miscellanea Paleontologica no 9, Studi e Ricerche sui Giacimenti Terziari di Bolca (Museo Civico di Storia Naturale di Verona)* **12**, 99–107.
- Bannikov, A. F. 2009. On Early Sarmatian Fishes from the Eastern Paratethys. *Paleontological Journal* **43** (5), 569–73. [Translated from *Paleontologicheskii Zhurnal*.]
- Bannikov, A. F. 2010. *Iskopyayemye pozvonochnye Rossii i sopredelnykh stran. Iskopyayemye kolyuchepyyrye ryby (Teleostei, Acanthopterygii)*. [Fossil Vertebrates of Russia and Adjacent Countries. Fossil Acanthopterygian Fishes (Teleostei, Acanthopterygii)]. Moscow: GEOS.
- Bannikov, A. F. 2012. The first record of the genus *Isurichthys* (Perciformes, Ariommatidae) in the Lower Oligocene of the Northern Caucasus. *Paleontological Journal* **46** (2), 171–76. [Translated from *Paleontologicheskii Zhurnal*.]
- Bannikov, A. F. & Fedotov, V. F. 1989. O sistematicheskoy polo-zhenii okuneobraznykh rodov *Lednevia* i *Abadzekhia* iz Maykopa yuga SSSR. *Byulleten' Moskovskogo Obshchestva Ispytatelei Prirody, Otdel Geologicheskii* **64** (5), 85–90.
- Bannikov, A. F. & Parin, N. N. 1997. The list of marine fishes from Cenozoic (Upper Paleocene–Middle Miocene) localities in southern European Russia and adjacent countries. *Journal of Ichthyology* **37** (2), 133–46. [Translated from *Voprosy Ikhtiologii*.]
- Bannikov, A. F. & Parin, N. V. 1995. Description of a new species of scabbardfish (Aphanopinae: Trichiuridae) from the Middle Eocene of the Northern Caucasus, with restoration of the validity of the fossil genus *Anencheilum*. *Journal of Ichthyology* **35** (9), 183–92 [Translated from *Voprosy Ikhtiologii*.]
- Bannikov, A. F. & Sorbini, L. 1984. On the occurrence of genus *Scombrosarda* in the Eocene of Bolca. *Miscellanea Paleontologica, Studi e Ricerche sui Giacimenti Terziari di Bolca (Museo Civico di Storia Naturale di Verona)* **4**, 308–17.
- Bannikov, A. F. & Tyler, J. C. 1995. Phylogenetic revision of the fish families Luvaridae and †Kushlukidae (Acanthuroidei), with a new genus and two new species of Eocene luvarids. *Smithsonian Contributions to Paleobiology* **81**, 1–45.
- Birdsong, R. S., Murdy, E. O. & Pezold, F. L. 1988. A study of the vertebral column and median fin osteology in gobioid fishes, with comments on gobioid relationships. *Bulletin of Marine Science* **42**, 174–214.
- Blainville, H. D. de 1818. Sur les ichthyolites ou les poissons fossiles. In *Nouveau Dictionnaire d'Histoire Naturelle, appliquée aux Arts, à l'Economie Rurale et Domestique, à la Médecine, etc.* **27**, 310–95.
- Bleeker, P. E. 1859. Enumeratio Specierum Piscium hucusque in Archipelago Indico observatarum, adjectis habitationibus citationibusque, ubi descriptiones earum recentiores reperiuntur, nec non speciebus Musei Bleekeriani Bengalensibus, Japonicis, Capensibus, Tasmanicisque. *Verhandelingen der Natuurkundige Vereeniging in Nederlandsch Indië* **6**, i–xxxvi, 1–276.
- Bleeker, P. E. 1869. Neuvième notice sur la faune ichthyologique du Japon. *Verslagen en Mededeelingen der Koninklijke Akademie van Wetenschappen, Afdeling Natuurkunde, 2e Reeks* **3**, 237–52.
- Bloch, M. E. 1973. *Naturgeschichte der Ausländischen Fische*, Vol. 7. Berlin.
- Bogachev, V. V. 1933. Materialy po izucheniyu tretichnoi ikhtiofauny Kavkaza. *Trudy Azerbaidzhanskogo Neftyanogo Instituta, Geologicheskii Otdel* **15**, 1–62.
- Böhm, B. 1942. Beiträge zur tertiären Fischfauna Ungarns. *Geologica Hungarica, Seria Palaeontologica* **19**, 1–42.
- Broili, F. & Schlosser, M. 1923. *Grundzüge der Paläontologie (Paläozoologie) von Karl A. von Zittel. II Abteilung: Vertebrata*, Vol. 4. Munich & Berlin: R. Oldenbourg.
- Carnevale, G. 2006. A new snake mackerel from the Miocene of Algeria. *Palaeontology* **49**, 391–403.
- Carnevale, G., Bannikov, A. F., Landini, W. & Sorbini, C. 2006. Volhynian (early Sarmatian *sensu lato*) fishes from Tsurevsky, North Caucasus, Russia. *Journal of Paleontology* **80** (4), 684–99.
- Carpenter, K. E., Collette, B. B. & Russo, J. L. 1995. Unstable and stable classifications of scombroid fishes. *Bulletin of Marine Science* **56**, 379–405.
- Casier, E. 1966. *Faune ichthyologique du London Clay*, 2 Vols (Text and Plates). London: Trustees of the British Museum (Natural History).
- Ciobanu, M. 1970. Date noi asupra peștilor fosili din Oligocenul de la Piatra Neamț (II). *Studii și Cercetări de Geologie, Geografie, Biologie, Muzeologie-Muzeul de Științe Naturale din Piatra Neamț* **1**, 67–90.
- Ciobanu, M. 1977. *Fauna Fossilă din Oligocenul de la Piatra Neamț*. București: Editura Academiei Republicii Socialiste România.
- Ciobanu, M. 1978. Date noi asupra peștilor fosili din Oligocenul de la Piatra Neamț (IV). *Anuarul Muzeului de Științe Naturale Piatra Neamț, Seria Geologie-Geografie* **4**, 185–92.

- Clerget, Y. 1980. *Méthodes et résultats de la paléontologie, la Marnière de Froidefontaine: Paléobiologie et paléoécologie*. Besançon, France: CRDP.
- Cocco, A. 1829. Su di alcuni nuovi pesci del mar di Messina. *Giornale di Scienze, Arte e Lettere di Sicilia* **26**, 138–47.
- Collette, B. B. 1978. Adaptations and systematics of the mackerels and tunas. In Sharp, G. D. & Dizon, A. E. (eds) *The Physiological Ecology of Tunas*, 7–39. New York: Academic Press.
- Collette, B. B., Pothoff, T., Richards, W. J., Ueyanagi, S., Russo, J. L. & Nishikawa, Y. 1984. Scombroidei: development and relationships. In Moser, H. G., Richards, W. J., Cohen, D. M., Fahay, M. P., Kendall, A. W., Jr & Richardson, S. L. (eds) *Ontogeny and Systematics of Fishes. Special Publication 1*, 591–620. Lawrence, Kansas: American Society of Ichthyologists and Herpetologists.
- Collette, B. B., Reeb, C. & Block, B. A. 2001. Systematics of the tunas and mackerels (Scombridae). In Block, B. A. & Stevens, E. D. (eds) *Tuna: physiology, ecology and evolution. Fish Physiology Series 19*, 5–34. San Diego and London: Academic Press.
- Collette, B. B. & Chao, L. N. 1975. Systematics and morphology of the bonitos (*Sarda*) and their relatives (Scombridae, Sardini). *Fishery Bulletin* **73**, 516–625.
- Collette, B. B. & Nauen, C. E. 1983. FAO species catalogue. Vol. 2. Scombrids of the world. An annotated and illustrated catalogue of tunas, mackerels, bonitos and related species known to date. *FAO Fisheries Synopsis* **125** (2), 1–137.
- Collette, B. B. & Russo, J. L. 1985. Morphology, systematics and biology of the Spanish mackerels (*Scomberomorus*, Scombridae). *Fishery Bulletin* **82** (for 1984), 545–692.
- Compagno, L. J. V. 1984. FAO species catalogue. Vol. 4. Sharks of the world. An annotated and illustrated catalogue of shark species known to date. Part 2. Carcharhiniformes. *FAO Fisheries Synopsis* **125** (4, part 2), 251–655.
- Coryndon, S. C. 1977. The taxonomy and nomenclature of the Hippopotamidae (Mammalia, Artiodactyla) and a description of two new fossil species. *Proceedings of the Koninklijke Akademie van Wetenschappen, Series B* **80**, 61–88.
- Cuvier, G. 1829. *Le Règne Animal*, Vol. 2. Nouvelle Edition. Paris: Déterville.
- Cuvier, G. & Valenciennes, A. 1832. *Histoire naturelle des poissons*, Vol. 8. Paris: F. G. Levrault.
- Daniil'chenko, P. G. 1951. Tunets iz eotsenovykh otlozhenii Kavkaza. *Doklady Akademii Nauk SSSR* **77**, 881–83.
- Daniil'chenko, P. G. 1960. Kostistye ryby maykopskikh otlozhenii Kavkaza. *Trudy Paleontologicheskogo Instituta Akademii Nauk SSSR* **78**, 1–208.
- Daniil'chenko, P. G. 1962. Ryby dabakhanskoi svity Gruzii. *Paleontologicheskii Zhurnal* **1**, 111–26.
- Daniil'chenko, P. G. 1964. Nadotryad Teleostei, kostistye ryby [Suborder Teleostei, bony fishes]. In Obruchev, D. V. (ed.) *Osnovy paleontologii. Beschelyustnye, ryby*, 396–472. Moscow: Nauka.
- Daniil'chenko, P. G. 1967. *Bony fishes of the Maikop Deposits of the Caucasus*. Jerusalem: Israel Program for Scientific Translations. [Translation of Daniil'chenko 1960.]
- Daniil'chenko, P. G. 1968. Ryby verkhnego paleotsena Turkmenii. In Obruchev, D. V. (ed.) *Ocherki po filogenii i sistematike iskopyemykh ryb i beschelyustnykh*. Moscow: Nauka.
- Daniil'chenko, P. G. 1980. Otryad Perciformes. In Novitskaya, L. I. (ed.) *Iskopayemye kostistye ryby SSSR. Trudy Paleontologicheskogo Instituta Akademii Nauk SSSR* **178**, 115–69.
- David, L. R. 1943. Miocene Fishes of Southern California. *Geological Society of America Special Papers* **43**, 1–193.
- Day, J. J. 2003. Evolutionary relationships of the Sparidae (Teleostei: Percoidei): integrating fossil and Recent data. *Transactions of the Royal Society of Edinburgh: Earth Sciences* **93** (for 2002), 333–53.
- Donoghue, M. J., Doyle, J. A., Gauthier, J., Kluge, A. G. & Rowe, T. 1989. The importance of fossils in phylogeny reconstruction. *Annual Review of Ecology and Systematics* **20**, 431–60.
- Dubois, G. & Dubois, C. 1955. La géologie de l'Alsace. Aperçu général et excursions géologiques. *Mémoires de la Service de Carte Géologique d'Alsace Lorraine* **13**, 1–310.
- Dzhafarova, Zh. D. 1962. Maykopskiye ryby Akburuna. *Doklady Akademii Nauk Azerbaidzhanskoi SSR* **18** (11), 47–51.
- Dzhafarova, Zh. D. 1988. *Predstavitel' semeistva Trichiuridae s otolitom v khadumskikh otlozheniyakh Apsheronского poluoostrova*. Manuscript dep. VINITI, no. 7581-C, Baku (Azerbaijan).
- Euphrasen, B. A. 1788. Beskrifning på trenne fiskar. *Kungliga Svenska Vetenskaps-Akademiens Handlingar* **9**, 51–55.
- Falconer, H. & Cautley, P. T. 1836. Note on the fossil hippopotamus of the Siwalik Hills. *Asiatic Research Calcutta* **19**, 39–53.
- Fierstine, H. L. 2001. A new †*Aglyptorhynchus* (Perciformes: Scombroidei: †Blochiidae) from the Late Oligocene of Oregon. *Journal of Vertebrate Paleontology* **21** (1), 24–33.
- Fierstine, H. L. 2006. Fossil history of billfishes (Xiphiidae). *Bulletin of Marine Science* **79**, 433–53.
- Fierstine, H. L., Bannikov, A. F. & Monsch, K. A. 2008. A new species of the palaeorhynchid fish genus *Palaeorhynchus* from the late early Eocene of Bolca in northern Italy (Xiphiidae, Palaeorhynchidae). *Miscellanea Paleontologica n. 9, Studi e Ricerche sui Giacimenti Terziari di Bolca (Museo Civico di Storia Naturale di Verona)* **12**, 7–28.
- Fierstine, H. L. & Monsch, K. A. 2002. Redescription and phylogenetic relationships of the family Blochiidae (Perciformes: Scombroidei), Middle Eocene, Monte Bolca, Italy. *Miscellanea Paleontologica n. 6, Studi e Ricerche sui Giacimenti Terziari di Bolca (Museo Civico di Storia Naturale di Verona)* **9**, 121–63.
- Fowler, H. W. 1929. New and little-known fishes from the Natal coast. *Annals of the Natal Museum* **6**, 245–64.
- Gago, F. J. 1997. Character evolution and phylogeny of the cutlassfishes: an ontogenetic perspective (Scombroidei: Trichiuridae). *Bulletin of Marine Science* **60**, 161–91.
- Gago, F. J. 1998. Osteology and phylogeny of cutlassfishes (Scombroidei: Trichiuridae). *Contributions in Science, Natural History Museum of Los Angeles County* **476**, 1–79.
- Gauthier, J., Kluge, A. G. & Rowe, A. T. 1988. Amniote phylogeny and the importance of fossils. *Cladistics* **4**, 105–209.
- Giebel, C. G. A. 1847. *Die Fische. 3: Fauna der Vorwelt mit Steter Berücksichtigung der Lebenden Thiere*. Leipzig.
- Gill, T. N. 1862. On the limits and arrangements of the family of scombroids. *Proceedings of the Academy of Natural Sciences of Philadelphia* **14**, 124–27.
- Gill, T. N. 1893. A comparison of antipodal faunas. *Memoirs of the National Academy of Sciences* **6**, 91–124.
- Gosline, W. A. 1968. The suborders of perciform fishes. *Proceedings of the US National Museum* **124**, 1–78.
- Goüan, A. 1770. *Historia Piscium, Sistens Ipsorum Anatomem Externam, Internam, atque Genera in Classes et Ordines Redacta*. Strasbourg: Amand König.
- Gregory, W. K. & Conrad, G. M. 1937. The comparative osteology of the swordfish (*Xiphias*) and the sailfish (*Istiophorus*). *American Museum Novitates* **952**, 1–25.
- Günther, A. 1860. *Catalogue of the Fishes in the British Museum. Catalogue of the Actinopterygian Fishes in the Collection of the British Museum*, Vol. 2 (Squamipinnes, Cirrithidae, Triglidae, Trachinidae, Sciaenidae, Polynemidae, Sphyrænidae, Trichiuridae, Scombridae, Carangidae, Xiphiidae). London: Taylor & Francis.
- Günther, A. 1880. *An Introduction to the Study of Fishes*. Edinburgh: A. & Ch. Black.
- Heckel, J. J. 1850. Beiträge zur Kenntniss der fossilen Fische Österreichs. *Denkschriften von die Kaiserlichen Akademie der Wissenschaften, Mathematisch-naturwissenschaftliche Klasse* **1**, 201–42.
- Holland, C. H. 1983. Soviet and British stratigraphical classifications compared. *Journal of the Geological Society, London* **140**, 845–47.
- International Commission on Zoological Nomenclature (ICZN). 1999. *International Code of Zoological Nomenclature*, 4th edn. London: ICZN and the Natural History Museum.
- Jerzmańska, A. 1958. Stan badań nad rybami trzecziorzędowymi w Polsce. *Kwartalnik Geologiczny* **2**, 177–86.
- Jerzmańska, A. 1968. Ichthyofaune des couches à ménilite (Flysch des Karpathes). *Acta Palaeontologica Polonica* **13**, 379–496.
- Jerzmańska, A. & Kotlarczyk, J. 1981. Zmiany ewolucyjne ichtiofauny jako podstawa stratygrafii serii menilitowo-krośnieńskiej. *Zemni Plyn a Nafta* **26**, 63–74.
- Johnson, G. D. 1986. Scombroid phylogeny: an alternative hypothesis. *Bulletin of Marine Science* **39**, 1–41.
- Johnson, J. Y. 1862. Descriptions of some new genera and species of fishes obtained at Madeira. *Proceedings of the Zoological Society of London* **1862**, 343–437.
- Johnson, J. Y. 1865. Description of new genus of trichiurid fishes obtained at Madeira, with remarks on the genus *Dicrotus*, Günther, and on some allied genera of Trichiuridae. *Proceedings of the Zoological Society of London* **1865**, 434–37.
- Jonet, S. 1958. *Contribution à l'étude des schistes disodiques Oligocènes de Roumainie: Faune ichthyologique de Homoraciú District de Prahova*. Lisboa: Sociedade Tipográfica, LDA.
- Jordan, D. S. 1898. Description of a species of fish (*Mitsukurina owstoni*) from Japan, the type of a distinct family of lamnoid sharks. *Proceedings of the California Academy of Sciences (Zoology), Series 3* **1**, 199–202.

- Jordan, D. S. 1919. Fossil fishes of the Soledad Deposits of Southern California. *Leland Stanford Junior University Publications, University Series* **38**, 1–12.
- Jordan, D. S. 1921. The fish fauna of the California Tertiary. *Stanford University Publications, University Series, Biological Sciences* **1**, 233–300.
- Jordan, D. S. 1925. The fossil fishes of the Miocene of California. *Stanford University Publications, University Series, Biological Sciences* **4**, 1–51.
- Jordan, D. S. & Gilbert, C. H. 1883. Notes on a collection of fishes from Charleston, South Carolina, with descriptions of three new species. *Proceedings of the United States National Museum* **5**, 580–620.
- Jordan, D. S. & Gilbert, J. Z. 1919. Fossil fishes of Southern California. *Leland Stanford Junior University Publications, University Series* **38**, 13–60.
- Jordan, D. S. & Gilbert, J. Z. 1920. The fossil fishes of the Diatom beds of Lompoc, California. *Leland Stanford Junior University Publications, University Series* **42**, 1–45.
- Jordan, D. S. & Snyder, J. O. 1904. Notes on the collection of fishes from Oahu Island and Laysan Island, Hawaii, with descriptions of four new species. *Proceedings of the United States National Museum* **27**, 939–48.
- Jordan, D. S. & Starks, E. C. 1908. *Rastrelliger* Jordan and Starks, new genus. In Jordan, D. S. & Dickerson, M. C. On a collection of fishes from Fiji, with notes on certain Hawaiian fishes. *Proceedings of the United States National Museum* **34**, 607–09.
- Klunzinger, C. B. 1871. Synopsis der Fische des Rothen Meeres. II. Theil. *Verhandlungen der Königlich-Kaiserlichen zoologisch-botanischen Gesellschaft in Wien* **21**, 441–688.
- Kramberger, D. 1879. Beiträge zur Kenntnis der fossilen Fische der Karpathen. *Palaeontographica* **26**, 51–68.
- Lacépède, B. G. E. 1800. *Histoire Naturelle des Poissons*, Vol. 2. Paris: Plassan, Imprimeur-Libraire.
- Lacépède, B. G. E. 1802. *Histoire Naturelle des Poissons*, Vol. 4. New Ed. Paris: Plassan, Imprimeur-Libraire.
- Lednev, N. M. 1914. Die Fauna der Fischschichten der Halbinsel Apscheron. *Trudy Geologicheskogo Komiteta, Novaya Seriya (Mémoires du Comité Géologique, Nouvelle Série)* **80**, 1–65.
- Leidy, J. 1853. On the osteology of the head of *Hippopotamus*. *Journal of the Academy of Natural Sciences of Philadelphia* **2**, 207–24.
- Leidy, J. 1856. Description of two ichthyodorulites. *Proceedings of the Academy of Natural Sciences of Philadelphia* **8**, 11–12.
- Leriche, M. 1908. Note préliminaire sur des poissons nouveaux de l'Oligocène belge. *Bulletin de la Société Belge de Géologie, de Paléontologie et d'Hydrologie* **22**, 378–84.
- Leriche, M. 1910. Les poissons Oligocènes de la Belgique. *Mémoires du Musée Royal d'Histoire Naturelle de Belgique* **5**, 1–363.
- Lesson, R. P. 1831. Poissons. In Duperrey, L. I. (ed.) *Voyage autour du monde sur la corvette de La Majesté La Coquille, pendant les années 1822, 1823, 1824 et 1825. Zoologie* **2**, 66–238, pl. 1–38. Paris.
- Li, B., Dettai, A., Cruaud, C., Couloux, A., Desoutter-Meniger, M. & Lecointre, G. 2009. RNF213, a new nuclear marker for acanthomorph phylogeny. *Molecular Phylogenetics and Evolution* **50**, 345–63.
- Lieberman, B. S. 2003. Paleobiogeography: the relevance of fossils to biogeography. *Annual Review of Ecology, Evolution, and Systematics* **34**, 51–69.
- Linnaeus, C. 1758. *Systema naturae per regna tria naturae, secundum Classes, Ordinus, Genera, Species, cum characteribus, differentiis, synonymis, locis*. Vol. 1, 10th ed. Holmiae (Stockholm): Laurentii Salvii.
- Little, A. G., Lougheed, S. C. & Moyes, C. D. 2010. Evolutionary affinity of billfishes (Xiphiidae and Istiophoridae) and flatfishes (Pleuronectiformes): Independent and trans-subordinal origins of endothermy in teleost fishes. *Molecular Phylogenetics and Evolution* **56**, 897–904.
- Mabee, P. M. 1988. Supraneural and predorsal bones in fishes: development and homologies. *Copeia* **1988**, 827–38.
- Matsubara, K. & Iwai, T. 1958. Anatomy and relationships of the Japanese fishes of the family Gempylidae. *Memoirs of the College of Agriculture, Kyoto University Special number*, 23–54.
- Matsui, T. 1967. Review of the mackerel genera *Scomber* and *Rastrelliger* with description of a new species of *Rastrelliger*. *Copeia* **1967**, 71–82.
- Menner, V. V. 1949. Klass Pisces, ryby. In *Atlas rukovodyashchikh form iskopayemykh faun SSSR*, Vol. **13** (Neogen). Moscow: Gosgeolizdat.
- Menner, V. V. & Ryabinin, A. N. 1949. Klass Pisces, ryby. In Ryabinin, A. N. & Korobkov, A. I. (eds) *Atlas rukovodyashchikh form iskopayemykh faun SSSR*, Vol. **12** (Paleogen). Moscow: Gosgeolizdat.
- Micklich, N. 1998. New information on the fish fauna of the Frauenweiler fossil site. *Italian Journal of Zoology* **65** (suppl), 169–84.
- Mohseni, H., Behbahani, R., Khodabakhsh, S. & Atashmard, Z. 2011. Depositional environments and trace fossil assemblages in the Pabdeh Formation (Paleogene), Zagros Basin, Iran. *Neues Jahrbuch für Geologie und Paläontologie* **262**, 59–77.
- Monod, T. 1968. Le complexe urophore des poissons téléostéens. *Mémoires de l'Institut Fondamental d'Afrique Noire* **81**, 1–705.
- Monsch, K. A. 2000a. A new fossil bonito (Sardini, Teleostei) from the Eocene of England and the Caucasus, and evolution of tail region characters of its Recent relatives. *Paleontological Research* **4**, 75–80.
- Monsch, K. A. 2000b. *The phylogeny of the scombroid fishes*. Unpublished PhD Thesis, University of Bristol, UK.
- Monsch, K. A. 2003. The use of apomorphies in taxonomic defining. *Taxon* **52**, 105–07.
- Monsch, K. A. 2005. Revision of the scombroid fishes from the Tertiary of England. *Transactions of the Royal Society of Edinburgh: Earth Sciences* **95** (for 2004), 445–89.
- Monsch, K. A. 2006. A revision of scombrid fishes (Scombroidei, Perciformes) from the middle Eocene of Monte Bolca, Italy. *Palaeontology* **49**, 873–88.
- Muzylev, N. G. 1994. Anoksicheskiye sobytiya paleotsena-srednego eotsena. In Rozanov, A. Yu. & Semikhatov, M. A. (eds) *Ekosistemnye perestroiki i evolyutsiya biosfery* **1**, 160–66. Moscow: Nedra.
- Nakamura, I. 1983. Systematics of the billfishes (Xiphiidae and Istiophoridae). *Publications of the Seto Marine Biological Laboratory* **28**, 255–396.
- Nakamura, I. 1985. FAO species catalogue. Vol. 5. Billfishes of the world. An annotated and illustrated catalogue of marlins, sailfishes, spearfishes and swordfishes known to date. *FAO Fisheries Synopsis* **125** (5), 1–65.
- Nakamura, I. & Fujii, E. 1983. A new genus and species of Gempylidae (Pisces: Perciformes) from Tonga Ridge. *Publications of the Seto Marine Biological Laboratory* **27**, 173–91.
- Nakamura, I. & Parin, N. V. 1993. FAO species catalogue. Vol. 15. Snake mackerels and cutlassfishes of the world (families Gempylidae and Trichiuridae). An annotated and illustrated catalogue of the snake mackerels, snoeks, escolars, gemfishes, sackfishes, domine, oilfish, cutlassfishes, scabbardfishes, hairtails and frostfishes known to date. *FAO Fisheries Synopsis* **125** (15), 1–136.
- Nauen, C. & Lauder, G. V. 2000. Locomotion in scombrid fishes: morphology and kinematics of the finlets of the chub mackerel *Scomber japonicus*. *Journal of Experimental Biology* **203**, 2247–59.
- Orrell, T. M., Collette, B. B. & Johnson, G. D. 2006. Molecular data support separate scombroid and xiphioid clades. *Bulletin of Marine Science* **79**, 505–19.
- Papazzoni, C. A. & Trevisani, E. 2006. Facies analysis, palaeoenvironmental reconstruction, and biostratigraphy of the 'Pesciara di Bolca' (Verona, northern Italy): An early Eocene Fossil-Lagerstätte. *Palaeogeography, Palaeoclimatology, Palaeoecology* **242**, 21–35.
- Patterson, C. 1993. Osteichthyes: Teleostei. In Benton, M. J. (ed.) *The Fossil Record 2*. London: Chapman & Hall.
- Paucă, M. 1929a. Vorläufige Mitteilung über eine fossile Fischfauna aus den Oligozänschiefern von Suslănești (Muscel). *Bulletin de la Section Scientifique de l'Académie Roumaine* **12**, 112–20.
- Paucă, M. 1929b. Fossile Fische aus dem rumänischen Alttertiär. *Bulletin de la Section Scientifique de l'Académie Roumaine* **12**, 121–24.
- Paucă, M. 1929c. Fossile Fische aus dem rumänischen Tertiär (Vorläufige Mitteilung). *Bulletin de la Section Scientifique de l'Académie Roumaine* **12**, 206–12.
- Paucă, M. 1930. Revision der fossilen Lepidopus- und Capros-Arten. *Bulletin de la Section Scientifique de l'Académie Roumaine* **13**, 177–83.
- Paucă, M. 1934. Die fossile Fauna und Flora aus dem Oligozän von Suslănești-Muscel in Rumänien. *Anuarul Institutului Geologic al României* **16**, 575–668.
- Pharisat, A. 1974. Complément statistique à l'étude de la faune ichthyologique fossile de l'Oligocène de Froidefontaine (Territoire de Belfort). *Bulletin de la Société d'Histoire Naturelle du Pays de Montbéliard* **1974**, 44–46.
- Pharisat, A. 1990. La paléichthyofaune du Rupélien marin de Froidefontaine (Territoire de Belfort). In *Congrès National de Paléontologie (Résumés)*, 17–19 mai 1990, Paris. Paris: SGF.
- Pharisat, A. 1991. La paléichthyofaune du Rupélien marin de Froidefontaine (Territoire de Belfort). Taxinomie et populations, genèse du gisement, implications paléobiogéographiques. *Annales*

- Scientifiques de l'Université de Franche-Comté, Besançon, Géologie* **4** (11), 13–97.
- Poey, F. 1851–1854. *Memorias sobre la historia natural de la isla de Cuba, acompañadas de sumarios Latinos y extractos en Francés*, Vol. 1. La Habana: Imprenta de la Viuda de Barcina.
- Popov, S. V., Akhmetiev, M. A., Zaporozhets, N. I., Voronina, A. A. & Stolyarov A. S. 1993a. Evolution of eastern Paratethys in the Late Eocene-Early Miocene. *Stratigraphy and Geological Correlation* **1** (6), 10–39. [Translated from *Stratigrafiya. Geologicheskaya Korrelyatsiya*.]
- Popov, S. V., Voronina, A. A. & Goncharova, I. A. 1993b. Stratigrafiya i dvustvorchatye mollyuski oligotsena-nizhnego miotsena Vostochnogo Paratetisa. *Trudy Paleontologicheskogo Instituta* **256**, 1–208.
- Popov, S. V., Akhmetiev, M. A., Burgova, E. M., Lopatin, A. V., Amitrov, O. V., Andreyeva-Grigorovich, A. S., Zaporozhets, N. I., Zherikhin, V. V., Krashennnikov, V. A., Nikolaeva, I. A., Sytchevskaya, E. K. & Shcherba, I. G. 2002. Biogeography of the northern Peri-Tethys from the Upper Eocene to the Lower Miocene. Part 2. Early Oligocene. *Paleontological Journal* **36** (suppl. 3), S185–S259.
- Potthoff, T. 1975. Development and structure of the caudal complex, the vertebral column and the pterygiophores in the blackfin tuna (*Thunnus atlanticus*), Scombridae. *Bulletin of Marine Science* **25**, 205–31.
- Prokofiev, A. M. 2002. A new genus of cutlassfish from the Upper Paleocene of Turkmenistan (Scombroidei: Trichiuroidea). *Zoosystematica Rossica* **11** (1), 229–33.
- Prokofiev, A. M. 2004. Caudal skeleton of the enigmatic Upper Paleocene xiphioid fish *Hemingwaya sarissa* Sytchevskaya & Prokofiev, 2002: a new interpretation, with some emendations to the diagnosis of the family (Teleostei: Xiphioidea: Hemingwayidae). *Zoosystematica Rossica* **13** (1), 125–27.
- Rafinesque-Schmaltz, C. S. 1810. *Caratteri di Alcuni Novi Generi e Nuove Specie di Animali (Principalmente di Pesci)*. Palermo.
- Rafinesque-Schmaltz, C. S. 1815. *Analyse de la Nature, ou Tableau de l'Univers et de Corps Organisées*. Palermo.
- Romanovsky, G. D. 1886. O novom rode iskopayemoy ryby s Kavkaza. *Zapiski Vserossiyskogo Mineralogicheskogo Obshchestva* **22**, 304–06.
- Rüppell, W. P. E. S. 1835–1838. *Neue Wirbeltiere zu der Fauna von Abyssinien gehörig. Fische des Rothen Meeres*. Frankfurt-am-Main.
- Russo, J. L. 1983. *Interrelationships of the gempylid fishes (Teleostei, Scombroidei)*. Unpublished PhD Thesis, The George Washington University, Washington, DC.
- Rychlicki, J. 1909. Przyczynek do fauny ryb karpatskich łupków menilitowych. *Kosmos* **34**, 749–64.
- Sauvage, H. E. 1870. Synopsis des poissons tertiaires de Licata (Sicile). *Annales des Sciences Naturelles (Zoologie et Paléontologie)*, Sér. 5a **14** (7), 1–26.
- Sauvage, H. E. 1873. Mémoire sur la faune ichthyologique de la période tertiaire, et plus spécialement sur les poissons fossiles d'Oran (Algérie) et sur ceux découverts par M. R. Alby à Licata en Sicile. *Annales des Sciences Géologiques* **4**, 1–272.
- Scheuchzer, J. J. 1708. *Piscium querelae et vindiciae*. Tiguri (Zürich): Typis Gessnerianis.
- Schultz, O. 1987. Taxonomische Neugruppierung der Überfamilie Xiphioidea (Pisces, Osteichthyes). *Annalen des Naturhistorischen Museums, Wien, Serie A: für Mineralogie und Petrographie, Anthropologie und Prähistorie* **89**, 95–202.
- Smirnov, V. P. 1936. Ryby Severo-Kavkazskogo oligotsena (Chernorechenskii rayon) [Fishes of the North Caucasian Oligocene (Chyornaya Rechka District)]. *Trudy Uzbekskogo Gosudarstvennogo Universiteta* **1**, 1–92.
- Smith, W. L. & Wheeler, W. C. 2006. Venom evolution widespread in fishes: a phylogenetic road map for the bioprospecting of piscine venoms. *Journal of Heredity* **97**, 206–17.
- South, J. 1845. *Thunnus*. In Smedley, E., Rose, H. J. & Rose, H. J. (eds) *Encyclopaedia metropolitana; or, universal dictionary of knowledge*, Vol. 25. London: J. J. Griffin.
- Starks, E. C. 1910. The osteology and mutual relationships of the fishes belonging to the family Scombridae. *Journal of Morphology* **21**, 77–99.
- Stratigraficheskiy slovar' SSSR 1982. *Paleogen, neogen, chetvertichnaya sistema* [Stratigraphic Dictionary of the USSR. Paleogene, Neogene, Quaternary System]. Leningrad (St Petersburg): Nedra.
- Sylva, D. P. de 1955. The osteology and phylogenetic relationships of the blackfin tuna, *Thunnus atlanticus*. *Bulletin of Marine Science of the Gulf and the Caribbean* **5**, 1–41.
- Sytchevskaya, E. K. & Prokofiev, A. M. 2002. First findings of Xiphioidea (Perciformes) in the Upper Palaeocene of Turkmenistan. *Journal of Ichthyology* **42**, 227–37. (Translation from *Voprosy Ikhtologii*.)
- Taverne, L. 1988. On the synonymy of the priacanthid genera *Pristigenys* Agassiz, 1835 and *Pseudopriacanthus* Bleeker, 1869 (Teleostei, Percoidae). *Cybium* **12**, 171–72.
- Temnyuk, F. P. 1965. Nova znakhidka ikhtiofauny u verkhiv'yi r. Uzh i vik vmishchuyuchikh yiyi porid. *Dopovidi Akademii Nauk Ukrayinskoj RSR* **8**, 1076–8 [In Ukrainian.]
- Théobald, N. 1934. Contribution à la paléontologie du bassin Oligocène du Haut-Rhin et du territoire de Belfort. Les poissons Oligocènes. *Bulletin du Service de Carte Géologique d'Alsace* **2**, 117–62.
- Trelea, N., Saraiman, A. & Voicu, M. C. 1977. Contribuții la cunoașterea faunei fosile de pești din imprejurimile orașului Gura Humorului. III. *Analele Științifice ale Universității 'Al. I. Cuza' din Iași* **23**, 49–54. [In Romanian.]
- Tucker, D. W. 1956. Studies of the trichiurid fishes-3, A preliminary revision of the family Trichiuridae. *Bulletin of the British Museum (Natural History)*, Zoology **4**, 73–130.
- Udovichenko, N. I. & Nesov L. A. 1987. Sravneniye kompleksov khryashchevykh ryb i drugikh pozvonochnykh paleogena Pritashkentskikh Chuley (Maysk) i Ukrainy (Pirogovo). In *Biostratigrafiya, paleontologiya osadochnogo chekhla Ukrainy*. Kiev: Naukova Dumka.
- Upchurch, P. & Hunn, C. A. 2001. 'Time': the neglected dimension in cladistic biogeography? *Geobios* **35** (Mém. Spéc. 24), 277–86.
- Uyeno, T. & Fujii, S. 1975. A fish fossil of the family Scombridae from a Miocene bed in Toyama Prefecture, Japan. *Bulletin of the National Science Museum, Series C (Geology)* **1**, 11–16.
- Van Beneden, P.-J. 1873. Notice sur un nouveau poisson du terrain Bruxellien. *Bulletin de l'Académie Royale de Belgique, 2me Série* **35**, 255–59.
- Van Regteren Altena, C. O. 1958. A second fossil from Scheuchzer's collection in the Teyler Museum. *Centaurus* **1958**, 370–72.
- Volta, G. S. 1796. *Ittiolitologia Veronese del Museo Bozziano ora Annesso a quello del Conte Giovambattista Gazola e di Altri Gabinetti di Fossili Veronesi (con la Versione Latina)*. Verona: Stamperia Giuliani.
- Vom Rath, J. J. G. 1859. Beitrag zur Kenntnis der fossilen Fische des Plattenberges in Kanton Glarus. *Zeitschrift der Deutschen Geologischen Gesellschaft* **11**, 108–32.
- Von Zittel, K. A. 1887–1890. *Handbuch der Paläontologie. I Abteilung. Paläozoologie*, Vol. 3 (*Vertebrata: Pisces, Amphibia, Reptilia, Aves*). München & Leipzig: R. Oldenbourg.
- Waite, E. R. 1911. Additions of the fauna of New Zealand II. *Proceedings of the New Zealand Institute Part 2* **1911**, 49–51.
- Weiler, W. 1928. Fische aus dem rumänischen Tertiär. *Senckenbergiana* **10**, 1–54.
- Weiler, W. 1933. Zwei oligozäne Fischfaunen aus dem Königreich Ungarn. *Geologica Hungarica, Seria Palaeontologica* **11**, 1–54.
- Wettstein, A. 1886. Über die Fischfauna des Tertiären Glanerschiefers. *Abhandlungen der Schweizerischen Paläontologischen Gesellschaft* **8**, 1–103.
- Winkler, T. C. 1867. *Musée Teyler. Catalogue Systématique de la Collection Paléontologique*, Vol. 6. Haarlem: Teylers Museum.
- Woodward, A. S. 1889. *Catalogue of the fossil fishes in the British Museum (Natural History). Part I. Containing the Elasmobranchii*. London: British Museum (Natural History).
- Woodward, A. S. 1899. Note on *Scapanorhynchus*, a Cretaceous shark apparently surviving in Japanese seas. *Annals and Magazine of Natural History* **8**, 487–89.
- Woodward, A. S. 1901. *Catalogue of the fossil fishes in the British Museum (Natural History). Part IV. Containing the Actinopterygian Teleostomi of the suborders Isospondyli (in part), Ostariophysii, Apodes, Percosoces, Hemibranchii, Acanthopterygii and Anacanthini*. London: British Museum (Natural History).
- Żabrowski, M. 2002. Fishes from the family Trichiuridae (Perciformes) from menilite beds of Polish Carpathians. *The 7th European Workshop on Vertebrate Paleontology. Abstracts Volume and Excursions Field Guide*, 43. Bucharest: Ars Docendi Publishing House, University of Bucharest.
- Żabrowski, M. 2006. Different aspects of variability of bones of fishes from the family Trichiuridae (order Perciformes) from the Oligocene deposits of Paratethys. *Hantekeniana* **8**, 112.